

DUKANE

Portable LCD Projector Model 8774 & 8775



USER'S MANUAL

401-8774-8775-01

- IBM is a trademark or registered trademark of International Business Machines Corporation.
- Macintosh, Mac OS X and PowerBook are trademarks of Apple Computer, Inc., registered in the U.S. and other countries.
- Windows, Windows 98, Windows Me, Windows XP or Windows 2000 are trademarks or registered trademarks of Microsoft Corporation.
- Other product and company names mentioned in this user's manual may be the trademarks or registered trademarks of their respective holders.

NOTES

- (1) The contents of this guide may not be reprinted in part or whole without permission.
- (2) The contents of this guide are subject to change without notice.
- (3) Great care has been taken in the preparation of this manual; however, should you notice any questionable points, errors or omissions, please contact us.
- (4) Notwithstanding article (3), Dukane will not be responsible for any claims on loss of profit or other matters deemed to result from using the Projector.

Important Information

Safety Cautions

Precautions

Please read this manual carefully before using your projector and keep the manual handy for future reference. Your serial number is located on the bottom of your projector. Record it here:

CAUTION



To turn off main power, be sure to remove the plug from power outlet.
The power outlet socket should be installed as near to the equipment as possible, and should be easily accessible.

CAUTION



TO PREVENT SHOCK, DO NOT OPEN THE CABINET.
THERE ARE HIGH-VOLTAGE COMPONENTS INSIDE.
REFER SERVICING TO QUALIFIED SERVICE PERSONNEL.



This symbol warns the user that uninsulated voltage within the unit may be sufficient to cause electrical shock. Therefore, it is dangerous to make any kind of contact with any part inside of the unit.



This symbol alerts the user that important information concerning the operation and maintenance of this unit has been provided.
The information should be read carefully to avoid problems.

**WARNING: TO PREVENT FIRE OR SHOCK, DO NOT EXPOSE THIS UNIT TO RAIN OR MOISTURE.
DO NOT USE THIS UNIT'S PLUG WITH AN EXTENSION CORD OR IN AN OUTLET UNLESS ALL THE PRONGS CAN BE FULLY INSERTED.**

DOC Compliance Notice (for Canada only)

This Class B digital apparatus meets all requirements of the Canadian Interference-Causing Equipment Regulations.

Acoustic Noise Information Ordinance-3. GSGV (for Germany only):

The sound pressure level is less than 70 dB (A) according to ISO 3744 or ISO 7779.



This label is on the side of the remote control.

This mark is on the top of the remote control.

CAUTION



Use of controls or adjustments or performance of procedures other than those specified herein may result in hazardous radiation exposure.

CAUTION



Do not look into the laser pointer while it is on and do not point the laser beam at a person. Serious injury could result.

CAUTION



Avoid displaying stationary images for a prolonged period of time.
Doing so can result in these images being temporarily sustained on the surface of the LCD panel.
If this should happen, continue to use your projector. The static background from previous images will disappear.

WARNING TO CALIFORNIA RESIDENTS:

Handling the cables supplied with this product, will expose you to lead, a chemical known to the State of California to cause birth defects or other reproductive harm. Wash hands after handling.

Disposing of your used product



EU-wide legislation as implemented in each Member State requires that used electrical and electronic products carrying the mark (left) must be disposed of separately from normal household waste. This includes projectors and their electrical accessories or lamps. When you dispose of such products, please follow the guidance of your local authority and/or ask the shop where you purchased the product.

After collecting the used products, they are reused and recycled in a proper way. This effort will help us reduce the wastes as well as the negative impact such as mercury contained in a lamp to the human health and the environment at the minimum level.

The mark on the electrical and electronic products only applies to the current European Union Member States.

RF Interference (for USA only)

WARNING

The Federal Communications Commission does not allow any modifications or changes to the unit EXCEPT those specified by this manual. Failure to comply with this government regulation could void your right to operate this equipment. This equipment has been tested and found to comply with the limits for a Class B digital device, pursuant to Part 15 of the FCC Rules. These limits are designed to provide reasonable protection against harmful interference in a residential installation. This equipment generates, uses, and can radiate radio frequency energy and, if not installed and used in accordance with the instructions, may cause harmful interference to radio communications. However, there is no guarantee that interference will not occur in a particular installation.

If this equipment does cause harmful interference to radio or television reception, which can be determined by turning the equipment off and on, the user is encouraged to try to correct the interference by one or more of the following measures:

- Reorient or relocate the receiving antenna.
- Increase the separation between the equipment and receiver.
- Connect the equipment into an outlet on a circuit different from that to which the receiver is connected.
- Consult the dealer or an experienced radio / TV technician for help.

For UK only: In UK, a BS approved power cable with moulded plug has a Black (five Amps) fuse installed for use with this equipment. If a power cable is not supplied with this equipment please contact your supplier.

Important Safeguards

These safety instructions are to ensure the long life of your projector and to prevent fire and shock. Please read them carefully and heed all warnings.

Installation

- Do not place the projector in the following conditions:
 - on an unstable cart, stand, or table.
 - near water, baths or damp rooms.
 - in direct sunlight, near heaters or heat radiating appliances.
 - in a dusty, smoky or steamy environment.
 - on a sheet of paper or cloth, rugs or carpets.
- If you wish to have the projector installed on the ceiling:
 - Do not attempt to install the projector yourself.
 - The projector must be installed by qualified technicians in order to ensure proper operation and reduce the risk of bodily injury.
 - In addition, the ceiling must be strong enough to support the projector and the installation must be in accordance with any local building codes.
 - Please consult your dealer for more information.

Place the projector in a horizontal position

The tilt angle of the projector should not exceed 10 degrees, nor should the projector be installed in any way other than the desktop and ceiling mount, otherwise lamp life could decrease dramatically.



Fire and Shock Precautions

- Ensure that there is sufficient ventilation and that vents are unobstructed to prevent the build-up of heat inside your projector. Allow at least 4 inches (10cm) of space between your projector and a wall.
- Do not try to touch the ventilation outlet on the left front (when seen from the front) as it can become heated while the projector is turned on.
- Prevent foreign objects such as paper clips and bits of paper from falling into your projector. Do not attempt to retrieve any objects that might fall into your projector. Do not insert any metal objects such as a wire or screwdriver into your project. If something should fall into your projector, disconnect it immediately and have the object removed by a qualified service personnel.
- Do not place any objects on top of the projector.
- Do not touch the power plug during a thunderstorm. Doing so can cause electrical shock or fire.
- The projector is designed to operate on a power supply of 100-240V AC 50/60 Hz. Ensure that your power supply fits this requirement before attempting to use your projector.
- Do not look into the lens while the projector is on. Serious damage to your eyes could result.
- Keep any items such as magnifying glass out of the light path of the projector. The light being projected from the lens is extensive, therefore any kind of abnormal objects that can redirect light coming out of the lens, can cause unpredictable outcome such as fire or injury to the eyes.
- Do not cover the lens with the black lens cap or equivalent while the projector is on. Doing so can lead to melting of the cap and possibly burning your hands due to the heat emitted from the light output.
- Do not place any objects, which are easily affected by heat, in front of the projector lens or a projector exhaust vent. Doing so could lead to the object melting or getting your hands burned from the heat that is emitted from the light output and exhaust.
- Handle the power cable carefully. A damaged or frayed power cable can cause electric shock or fire.
 - Do not use any power cables than the supplied one.
 - Do not bend or tug the power cable excessively.
 - Do not place the power cable under the projector, or any heavy object.
 - Do not cover the power cable with other soft materials such as rugs.
 - Do not heat the power cable
 - Do not handle the power plug with wet hands.
- Turn off the projector, unplug the power cable and have the object removed by a qualified service personnel under the following conditions:
 - When the power cable or plug is damaged or frayed.
 - If liquid has been spilled into the projector, or if it has been exposed to rain or water.
 - If the projector does not operate normally when you follow the instructions described in this user's manual.
 - If the projector has been dropped or the cabinet has been damaged.
 - If the projector exhibits a distinct change in performance, indicating a need for service.
 - If the projector is not to be used for an extended period of time.
- Disconnect the power cable and any other cables before carrying the projector
- Turn off the projector and unplug the power cable before cleaning the cabinet or replacing the lamp.
- When using a LAN cable:
For safety, do not connect to the connector for peripheral device wiring that might have excessive voltage.

CAUTION

- Do not use the tilt-foot for purposes other than originally intended. Misuses such as using the tilt foot to carry or hang (from the wall or ceiling) the projector can cause damage to the projector.
- Do not send the projector in the soft case by parcel delivery service or cargo shipment. The projector inside the soft case could be damaged.
- Select [High] in Fan mode if you continue to use the projector for consecutive days. (From the menu, select [Setup - Options] → [Fan Mode] → [High].)
- Do not unplug the power cable from the wall outlet under any one of the following circumstances. Doing so can cause damage to the projector:
 - While the projector's lamp lights.
 - While the cooling fans are running. The cooling fans continue to work for 30 seconds after the projector is turned off.
 - While the PC CARD Access Indicator lights. Doing so can damage your PC memory card.

Remote Control Precautions

- Handle the remote control carefully.
- If the remote control gets wet, wipe it dry immediately.
- Avoid excessive heat and humidity.
- Do not heat, take apart, or throw batteries into fire.
- If you will not be using the remote control for a long time, remove the batteries.
- Ensure that you have the batteries' polarity (+/-) aligned correctly.
- Do not use new and old batteries together, or use different types of batteries together.
- Dispose of used batteries according to your local regulations.

Lamp Replacement

- To replace the lamp, follow all instructions provided on page [104](#).
- Be sure to replace the lamp when the message **[The lamp has reached the end of its usable life. Please replace the lamp.]** appears. If you continue to use the lamp after the lamp has reached the end of its usable life, the lamp bulb may shatter, and pieces of glass may be scattered in the lamp case. Do not touch them as the pieces of glass may cause injury.

If this happens, contact your dealer for lamp replacement.

A Lamp Characteristic

The projector has a high-pressure mercury lamp as a light source.

A lamp has a characteristic that its brightness gradually decreases with age. Also repeatedly turning the lamp on and off will increase the possibility of its lower brightness.

CAUTION:

When removing the lamp from a ceiling-mounted projector, make sure that no one is under the projector. Glass fragments could fall if the lamp has been burned out.

Table of Contents

Important Information	i
1. Introduction	1
1 What's in the Box?	1
2 Introduction to the Projector	2
Congratulations on Your Purchase of the Projector	2
Features you'll enjoy	2
About this user's manual	3
3 Part Names of the Projector	4
Front/Top	4
Carrying the Projector	4
Rear	5
Bottom	5
Top Features	6
Terminal Panel Features	7
4 Part Names of the Remote Control	8
Battery Installation	9
Operating Range for Wireless Remote Control	9
Remote Control Precautions	9
2. Installation and Connections	10
1 Setting Up the Screen and the Projector	10
Selecting a Location	10
Throw Distance and Screen Size	11
2 Making Connections	13
Connecting Your PC or Macintosh Computer	13
To connect SCART output (RGB)	15
Connecting an External Monitor	16
Connecting Your DVD Player with Component Output	17
Connecting Your VCR or Laser Disc Player	18
Connecting to a Network	19
Inserting and Removing a PC Card	21
PC Card Type	22
Connecting the Supplied Power Cable	23
3. Projecting an Image (Basic Operation)	24
1 Turning on the Projector	24
Note on Startup screen (Menu Language Select screen)	25
2 Selecting a Source	26
Selecting the computer or video source	26
3 Adjusting the Picture Size and Position	27
Adjust the Tilt Foot	27
Zoom	28
Focus	28

④ Correcting Keystone Distortion	29
Auto Keystone Correction	29
Manual Keystone Correction	29
⑤ Optimizing an RGB Image Automatically	31
Adjusting the Image Using Auto Adjust	31
⑥ Adjusting Volume Up & Down	31
⑦ Using the Laser Pointer	32
Setting the function switch	32
⑧ Turning off the Projector	33
⑨ After Use	33
4. Convenient Features	34
① Turning Off the Image and Sound	34
② Freezing a Picture	34
③ Enlarging and Moving a Picture	34
④ Changing Lamp Mode	34
⑤ Getting Integrated Help	35
⑥ Using a USB Mouse	35
⑦ Using Remote Mouse Receiver	36
⑧ Correcting Horizontal and Vertical Keystone Distortion (Cornerstone)	38
⑨ Making Freehand Drawings on a Projected Image (ChalkBoard)	41
⑩ Preventing Unauthorized Use of the Projector	42
⑪ Using a USB Memory Device	47
⑫ Operation Using an HTTP Browser	48
⑬ Using the Projector to Operate a Computer Connected on a Network (Desktop Control Utility 1.0)	51
5. Using the Viewer	56
① Making the Most out of the Viewer Function	56
② Operating the Viewer Function from the Projector (playback)	57
Projecting slides (Viewer)	57
Viewer Window Elements	58
Setting Option for Viewer	59
Exiting Viewer	60
Viewing Digital Images	60
③ Changing Background Logo	61
6. Using On-Screen Menu	62
① Using the Menus	62
② Menu tree	63
③ Menu Elements	65
④ Menu Descriptions & Functions [Source]	66
Computer 1 and 2	66
Computer 3 (8775 only)	66
Component	66

Video	66
S-Video	66
Viewer	66
LAN	66
[Entry List]	67
5 Menu Descriptions & Functions [Adjust]	69
[Picture]	69
[Image Options]	72
[Video]	75
[Sound]	76
6 Menu Descriptions & Functions [Setup]	77
[Basic]	77
[Menu]	79
[Security]	79
[Installation]	84
[Options]	94
[Tools]	96
7 Menu Descriptions & Functions [Information]	97
[Usage Time]	97
[Source Page1]	98
[Source Page2]	98
[LAN Built-in]	99
[LAN PC Card]	99
[LAN Wireless]	100
[Version]	100
8 Menu Descriptions & Functions [Reset]	101
Returning to Factory Default	101
 7. Maintenance	 102
1 Cleaning or Replacing the Filter	102
2 Cleaning the Cabinet and the Lens	103
3 Replacing the Lamp	104
 8. Appendix	 107
1 Troubleshooting	107
2 Specifications	110
3 Cabinet Dimensions	112
4 Pin Assignments of D-Sub COMPUTER 1/2 Input Connector	114
5 Compatible Input Signal List	115
6 PC Control Codes and Cable Connection	116
7 Using Software Keyboard	117
8 Troubleshooting Check List	118

1. Introduction

① What's in the Box?

Make sure your box contains everything listed. If any pieces are missing, contact your dealer. Please save the original box and packing materials if you ever need to ship your Projector.

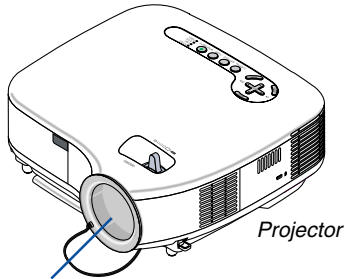

Projector

Lens cap
(24F41091)

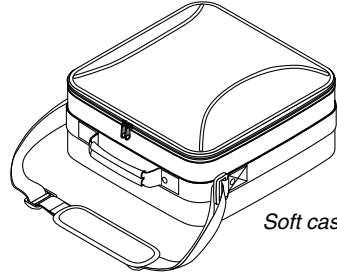

Soft case

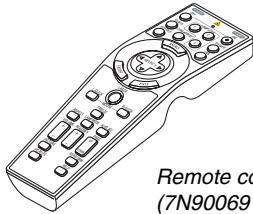

Remote control
(7N900691)

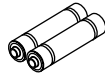

Batteries (AA x 2)

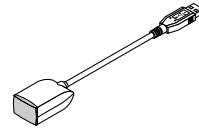

Remote mouse receiver
(7N900721)

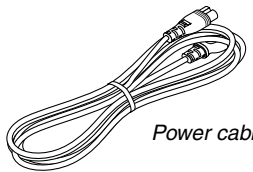

Power cable

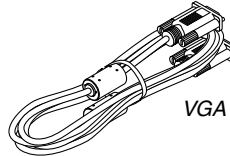

VGA signal cable

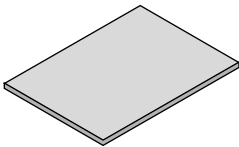

Operation Guide

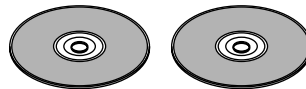

CD-ROM
User's manual and User Supportware 3

2 Introduction to the Projector

This section introduces you to the projector and describes key features and controls.

Congratulations on Your Purchase of the Projector

The 8774/8775 is a sophisticated XGA projector that produces an enhanced display. With the 8774/8775 you will be able to project images up to 300" (measured diagonally). Enjoy crisp and sharp large screen display from your PC, workstation or Macintosh computer, DVD player, VCR, satellite hookup, HDTV source,) and images from your digital camera PC Card, compact flash memory or USB storage device. The 8774/8775 provides for enhanced security options to help deter projector theft and provides for full projector control through the PC control port (mini D-Sub 9 Pin) and LAN support. With input and output flexibility, long lamp life and a full function remote, the 8774/8775 lets you enjoy larger than life viewing from a compact and easy to setup and use projector.

Features you'll enjoy :

- Quick start & quick cool down
15 seconds after turning on the power, the projector is ready to display PC or video images.
Powering down; The fans stop 30 seconds after turning off the power from the remote control or cabinet control panel. The projector can be put away immediately after the projector is powered down.
- Automatic vertical keystone correction for fast and easy application setup.
- 3D Reform™ enhanced image technology for increased projector placement versatility that provides for horizontal, vertical and diagonal keystone correction.
- Built-in Wall Color Correction presets provide for adaptive color correction when projecting onto non-white screen material (or a wall).
- USB memory or PC card interfaces provide for computer-free presentations.
- Enhanced smart security settings for password protection, cabinet control panel lock, menu lock and PC card protection key to help prevent unauthorized access, adjustments and theft deterrence.
- High resolution display - up to UXGA compatible, XGA native resolution.
- Variable audio out control of external amplified speakers via the projector remote.
- Extensive user adjustable picture and color management settings.
- Display 16:9 or 4:3 aspect ratio sources and fill the screen.
- HDTV (1080i, 720p) and SDTV (480p/576p, 480i/576i) compatibility.
- Digital photo viewer to display larger than life images from your digital cameras PC card, compact flash card or USB storage device.
- Integrated RJ-45 connector for wired networking capability.
- Wireless networking capable.
Present from anywhere in the room when using as a wireless LAN projector, no physical signal cable connection to a PC is required.
* The optional wireless LAN card is required (NWL-100* See page 86).
- Supplied User Supportware 3 CD-ROM containing five software utilities allowing you to make the most of you projector.
- The supplied wireless remote control and remote mouse receiver allows you to operate your PC mouse from across the room. The remote mouse receiver supports most PCs with USB interface.
- Easy set up, use and operation.
- Eco-mode lamp technology for increased lamp life, reduced energy consumption and overall total cost of ownership savings.
- Built-in laser pointer on the supplied remote control allows you to draw your audience's attention in a presentation.

- Free downloadable Software Geometric Correction Tool 3.0.
Corrects the geometry of an image projected onto a cylindrical, spherical or corner screen via serial connection.
For additional information visit:
US : www.dukcorp.com/av

About this user's manual

The fastest way to get started is to take your time and do everything right the first time. Take a few minutes now to review the user's manual. This may save you time later on. At the beginning of each section of the manual you'll find an overview. If the section doesn't apply, you can skip it.

3 Part Names of the Projector

Front/Top

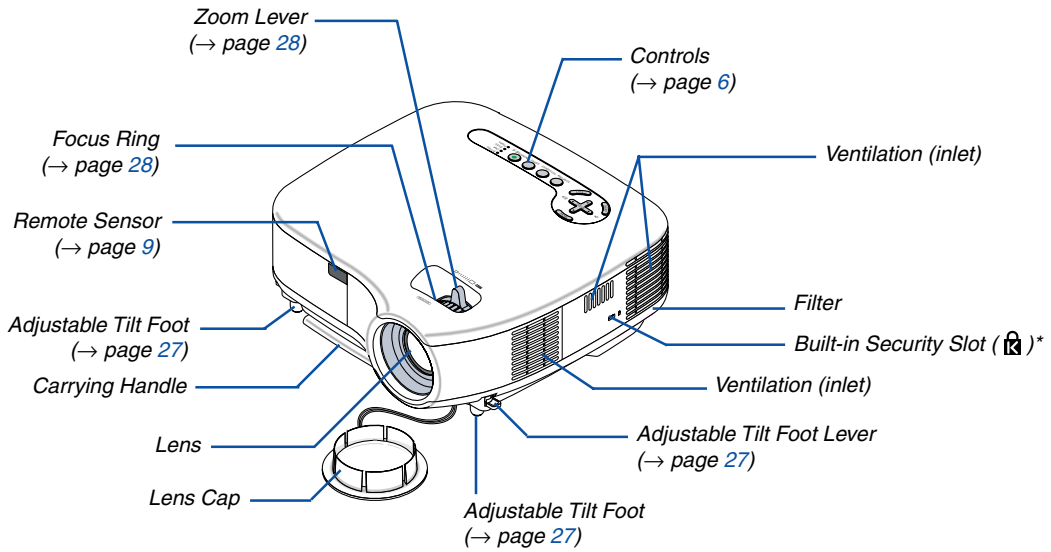

* This security slot supports the MicroSaver® Security System. MicroSaver® is a registered trademark of Kensington Microware Inc. The logo is trademarked and owned by Kensington Microware Inc.

Carrying the Projector

Always carry your projector by the handle.

Ensure that the power cable and any other cables connecting to video sources are disconnected before moving the projector.

When moving the projector or when it is not in use, cover the lens with the lens cap.

NOTE: To stand the projector on its end, do so by holding the cabinet, not by holding the carrying handle. Doing so can cause damage to the carrying handle.

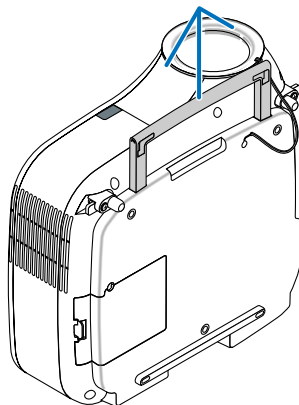

Rear

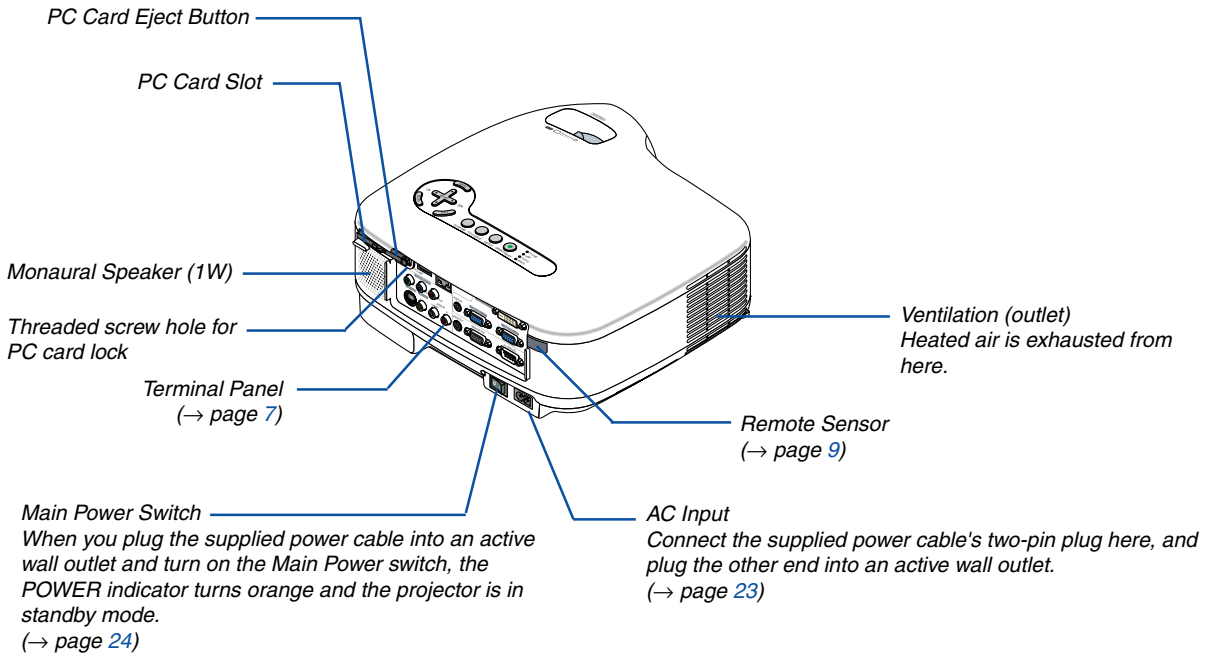

Bottom

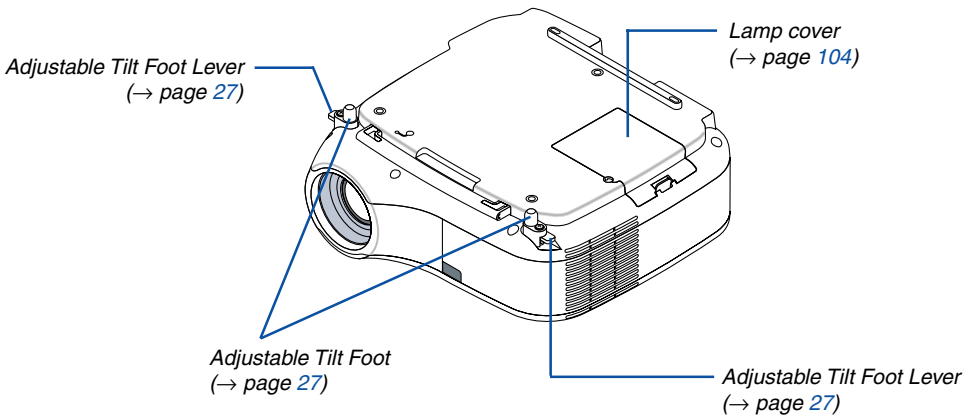

Top Features

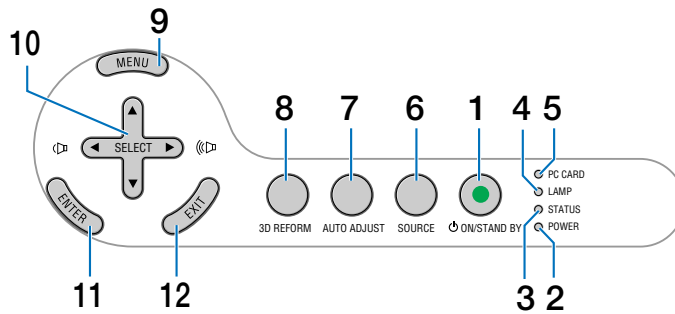

1. **POWER Button (ON / STAND BY)** (→ page 24, 33)

NOTE: To turn on the projector, press and hold this button for a minimum of two seconds. To turn off the projector, press this button twice.

2. **POWER Indicator ()** (→ page 24, 33, 107)

3. **STATUS Indicator** (→ page 107)

4. **LAMP Indicator** (→ page 104, 107)

5. **PC CARD Access Indicator** (→ page 22)

6. **SOURCE Button**

7. **AUTO ADJUST Button** (→ page 31)

8. **3D REFORM Button** (→ page 29, 38)

9. **MENU Button**

10. **SELECT ▲▼◀▶ (+) (-) / Volume Buttons**

11. **ENTER Button**

12. **EXIT Button**

Terminal Panel Features

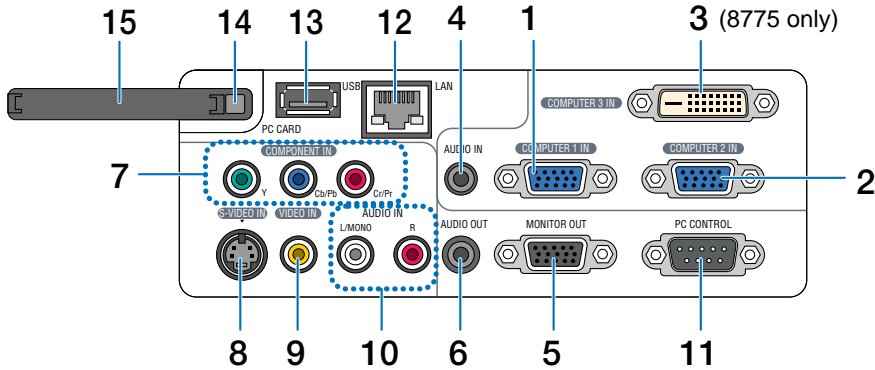

The actual appearance of the terminal panel may differ slightly from that shown in the drawing, but this does not affect the projector's performance.

- | | |
|---|---|
| <ul style="list-style-type: none"> 1. COMPUTER 1 IN/Component Connector (Mini D-Sub 15 Pin) (→ page 13, 15, 16) 2. COMPUTER 2 IN/Component Connector (Mini D-Sub 15 Pin) (→ page 13, 16) 3. COMPUTER 3 IN Connector (DVI-D 24 Pin) (HDCP compatible) (→ page 14) (Not available on LT280) 4. AUDIO IN (Stereo Mini Jack) (→ page 13, 14, 16) 5. MONITOR OUT Connector (Mini D-Sub 15 Pin) (→ page 16) 6. AUDIO OUT (Stereo Mini Jack) (→ page 16) 7. COMPONENT IN (Y, Cb/Pb, Cr/Pr) Connectors (RCA) (→ page 17) 8. S-VIDEO IN Connector (Mini DIN 4 Pin) (→ page 18) 9. VIDEO IN Connector (RCA) (→ page 18) 10. AUDIO L/MONO, R (RCA) (→ page 17, 18) | <ul style="list-style-type: none"> 11. PC CONTROL Port (Mini D-Sub 9 Pin) (→ page 116, 117)
Use this port to connect your PC or control system to control your projector via a serial cable. This enables you to control the projector using serial communication protocol. A commercially available RS232C cross cable is required to use this port. You can also control the projector by using PC Control Utility 3.0 contained on the supplied User Supportware 3 CD-ROM. To do so you must first have PC Control Utility 3.0 installed on your PC. If you are writing your own program, typical PC control codes are on page 116. 12. LAN Port (RJ-45) (→ page 19, 48) 13. USB Port (Type A) (→ page 35, 47) 14. PC CARD Eject Button (→ page 22) 15. PC CARD Slot (→ page 21) |
|---|---|

4 Part Names of the Remote Control

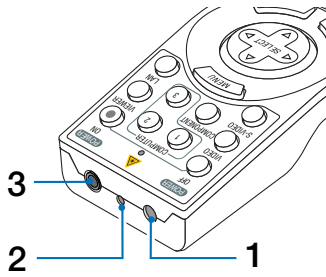

1. Infrared Transmitter

2. Laser Pointer

CAUTION:

- * Do not look into the laser pointer while it is on.
- * Do not point the laser beam at a person.

3. Remote jack (Not available on this model)

4. LED

Flashes when any button is pressed.

5. POWER ON Button (→ page 24)

NOTE: To turn on the projector, press and hold the POWER ON button for a minimum of two seconds.

6. POWER OFF Button (→ page 33)

NOTE: To turn off the projector, press the POWER OFF button twice.

7. COMPUTER 1 Button (→ page 26)

8. COMPUTER 2 Button (→ page 26)

9. COMPUTER 3 Button (→ page 26) (Not available on LT280)

10. VIDEO Button (→ page 26)

11. S-VIDEO Button (→ page 26)

12. COMPONENT Button (→ page 26)

13. VIEWER Button (→ page 26)

14. LAN Button (→ page 26)

15. MENU Button

16. SELECT ▲▼◀▶ Button

17. ENTER Button

18. EXIT Button

19. LASER Button (→ page 32)

20. MOUSE R-CLICK Button (→ page 37)

21. MOUSE L-CLICK Button (→ page 37)

22. FREEZE Button (→ page 34)

23. ASPECT Button (→ page 74)

24. VOLUME +/- Buttons (→ page 31)

25. PICTURE Button (→ page 69, 71)

26. PIC-MUTE Button (→ page 34)

27. MAGNIFY +/- Buttons (→ page 34)

28. LAMP MODE Button (→ page 34)

29. AUTO ADJ. Button (→ page 31)

30. PAGE UP/DOWN Buttons (→ page 37)

31. 3D REFORM Button (→ page 29, 38)

32. HELP Button (→ page 35)

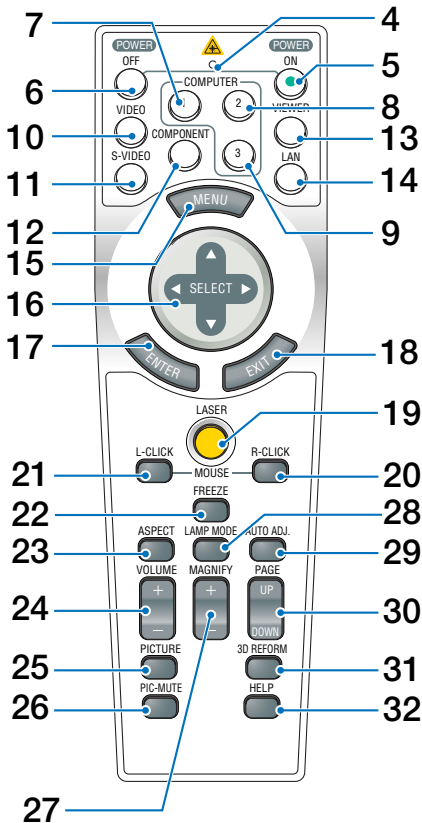

Battery Installation

1 Press the catch and remove the battery cover.

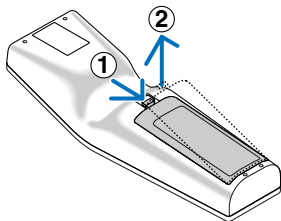

2 Install new ones (AA). Ensure that you have the batteries' polarity (+/-) aligned correctly.

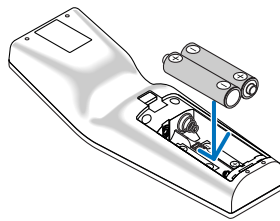

3 Slip the cover back over the batteries until it snaps into place.

NOTE: Do not mix different types of batteries or new and old batteries.

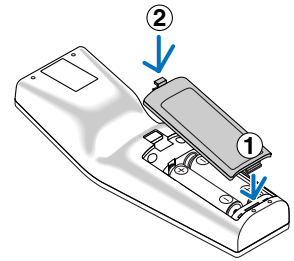

Operating Range for Wireless Remote Control

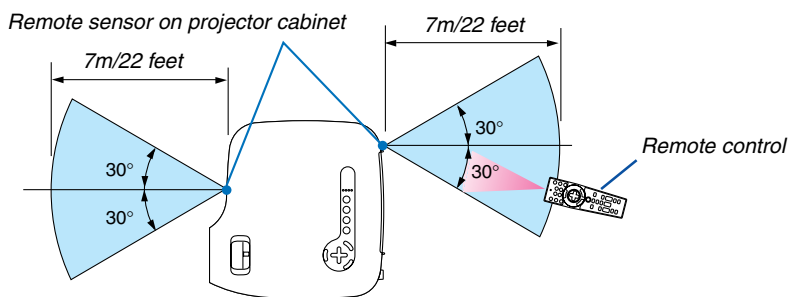

- The infrared signal operates by line-of-sight up to a distance of about 22 feet/7 m and within a 60-degree angle of the remote sensor on the projector cabinet.
 - The projector will not respond if there are objects between the remote control and the sensor, or if strong light falls on the sensor.
- Weak batteries will also prevent the remote control from properly operating the projector.

Remote Control Precautions

- Handle the remote control carefully.
- If the remote control gets wet, wipe it dry immediately.
- Avoid excessive heat and humidity.
- Do not heat, take apart, or throw batteries into fire.
- If you will not be using the remote control for a long time, remove the batteries.
- Ensure that you have the batteries' polarity (+/-) aligned correctly.
- Do not use new and old batteries together, or use different types of batteries together.
- Dispose of used batteries according to your local regulations.

2. Installation and Connections

This section describes how to set up your projector and how to connect PCs, video and audio sources.

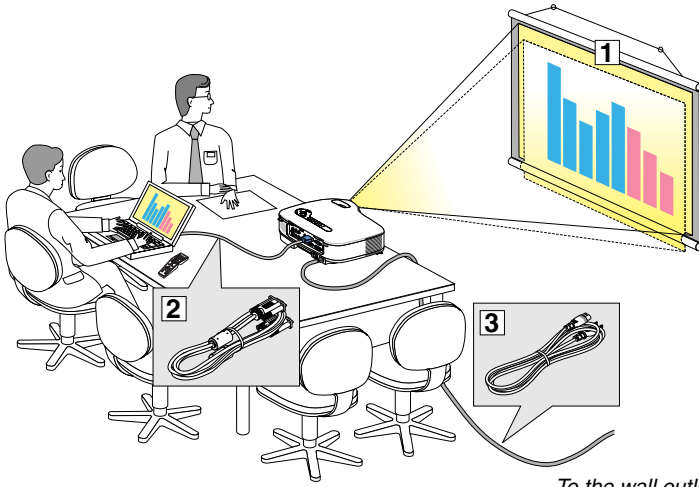

Your projector is simple to set up and use. But before you get started, you must first:

- 1 Set up a screen and the projector.
- 2 Connect your computer or video equipment to the projector. See pages 13 - 22.
- 3 Connect the supplied power cable. See page 23.

NOTE: Ensure that the power cable and any other cables are disconnected before moving the projector. When moving the projector or when it is not in use, cover the lens with the lens cap.

To the wall outlet.

1 Setting Up the Screen and the Projector

The further your projector is from the screen or wall, the larger the image. The minimum size the image can be is approximately 21 inches (0.5 m) measured diagonally when the projector is roughly 28 inches (0.7 m) from the wall or screen. The largest the image can be is 300 inches (7.6 m) when the projector is about 390 inches (10 m) from the wall or screen. Use the drawing below as a guide.

Selecting a Location

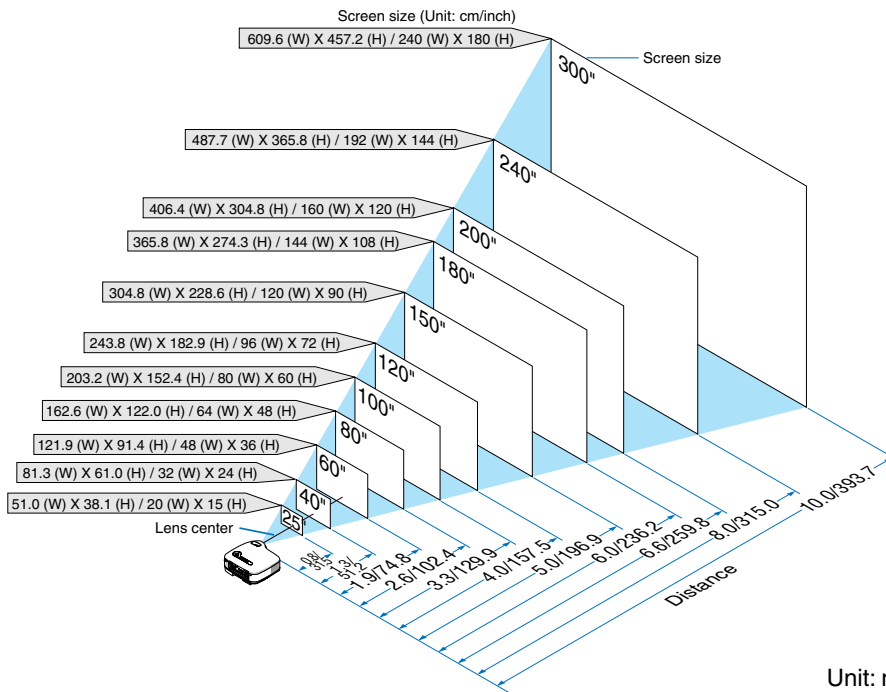

Unit: m/inch

TIP:

- The screen sizes above are intermediate values between tele (minimum display area) and wide (maximum display area). Image size can be adjusted with the zoom adjustment up to a maximum of 10%.
- To avoid premature lamp failure, do not tilt the front of the projector up or down by more than 10° from level.

2. Installation and Connections

Throw Distance and Screen Size

The following shows the proper relative positions of the projector and screen. Refer to the table to determine the position of installation.

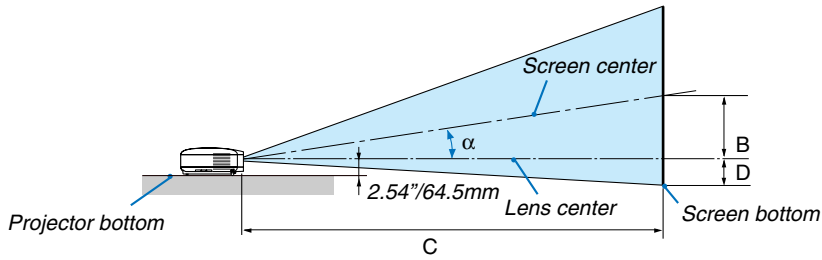

Distance Chart

B = Vertical distance between lens center and screen center

C = Throw distance

D = Vertical distance between lens center and screen bottom (top of screen for ceiling application)

α = Throw angle

NOTE: Distances may vary +/-5%.

8775

Screen Size			B	C		D	α
Diagonal	Width	Height		Wide - Tele	Wide - Tele		
inch	inch	inch	inch	inch	inch	degree	
21	17	13	5	-- 28	-2	-- 9.2	
25	20	15	5	27 - 33	-2	11.2 - 9.2	
30	24	18	6	33 - 41	-3	11.1 - 9.0	
40	32	24	9	45 - 55	-3	10.8 - 8.9	
60	48	36	13	69 - 84	-5	10.6 - 8.7	
72	58	43	16	83 - 102	-6	10.5 - 8.7	
80	64	48	17	93 - 113	-7	10.5 - 8.7	
84	67	50	18	98 - 119	-7	10.5 - 8.7	
90	72	54	19	105 - 128	-8	10.5 - 8.6	
100	80	60	22	117 - 142	-8	10.4 - 8.6	
120	96	72	26	141 - 171	-10	10.4 - 8.6	
150	120	90	32	176 - 214	-13	10.4 - 8.6	
180	144	108	39	212 - 257	-15	10.4 - 8.6	
200	160	120	43	236 - 286	-17	10.3 - 8.6	
210	168	126	45	248 - 301	-18	10.3 - 8.6	
240	192	144	52	284 - 344	-20	10.3 - 8.6	
270	216	162	58	320 - 387	-23	10.3 - 8.5	
300	240	180	65	356 - 431	-25	10.3 - 8.5	

Screen Size				B	C		D	α
Diagonal	Width	Height	Wide - Tele		Wide - Tele			
inch	mm	mm	mm	mm	mm	mm	degree	
21	533	427	320	115	-- 710	-45	-- 9.2	
25	635	508	381	137	690 - 850	-54	11.2 - 9.2	
30	762	610	457	164	840 - 1040	-64	11.1 - 9.0	
40	1016	813	610	219	1150 - 1400	-86	10.8 - 8.9	
60	1524	1219	914	329	1750 - 2140	-129	10.6 - 8.7	
72	1829	1463	1097	394	2120 - 2580	-154	10.5 - 8.7	
80	2032	1626	1219	438	2360 - 2870	-171	10.5 - 8.7	
84	2134	1707	1280	460	2480 - 3020	-180	10.5 - 8.7	
90	2286	1829	1372	493	2660 - 3240	-193	10.5 - 8.6	
100	2540	2032	1524	548	2970 - 3600	-214	10.4 - 8.6	
120	3048	2438	1829	657	3570 - 4340	-257	10.4 - 8.6	
150	3810	3048	2286	821	4480 - 5440	-322	10.4 - 8.6	
180	4572	3658	2743	986	5390 - 6540	-386	10.4 - 8.6	
200	5080	4064	3048	1095	6000 - 7270	-429	10.3 - 8.6	
210	5334	4267	3200	1150	6300 - 7640	-450	10.3 - 8.6	
240	6096	4877	3658	1314	7210 - 8740	-514	10.3 - 8.6	
270	6858	5486	4115	1479	8120 - 9840	-579	10.3 - 8.5	
300	7620	6096	4572	1643	9030 - 10940	-643	10.3 - 8.5	

8774

Screen Size			B	C		D	α
Diagonal	Width	Height		Wide - Tele	Wide - Tele		
inch	inch	inch	inch	inch	inch	degree	
21	17	13	5	-- 28	-1	-- 10.0	
25	20	15	6	28 - 34	-2	12.1 - 10.0	
30	24	18	7	34 - 41	-2	11.9 - 9.8	
40	32	24	10	46 - 56	-2	11.8 - 9.8	
60	48	36	14	69 - 84	-4	11.7 - 9.6	
72	58	43	17	83 - 102	-4	11.6 - 9.6	
80	64	48	19	93 - 113	-5	11.6 - 9.6	
84	67	50	20	98 - 119	-5	11.6 - 9.6	
90	72	54	21	105 - 127	-6	11.6 - 9.6	
100	80	60	24	117 - 141	-6	11.6 - 9.6	
120	96	72	29	141 - 170	-7	11.5 - 9.6	
150	120	90	36	176 - 213	-9	11.5 - 9.5	
180	144	108	43	211 - 256	-11	11.5 - 9.5	
200	160	120	48	235 - 285	-12	11.5 - 9.5	
210	168	126	50	247 - 299	-13	11.5 - 9.5	
240	192	144	57	283 - 342	-15	11.5 - 9.5	
270	216	162	64	318 - 385	-17	11.5 - 9.5	
300	240	180	72	354 - 428	-18	11.5 - 9.5	

Screen Size				B	C		D	α
Diagonal	Width	Height	Wide - Tele		Wide - Tele			
inch	mm	mm	mm	mm	mm	mm	degree	
21	533	427	320	127	-- 720	-33	-- 10.0	
25	635	508	381	152	710 - 860	-39	12.1 - 10.0	
30	762	610	457	182	860 - 1050	-47	11.9 - 9.8	
40	1016	813	610	243	1160 - 1410	-62	11.8 - 9.8	
60	1524	1219	914	364	1760 - 2140	-93	11.7 - 9.6	
72	1829	1463	1097	437	2120 - 2580	-112	11.6 - 9.6	
80	2032	1626	1219	485	2360 - 2870	-125	11.6 - 9.6	
84	2134	1707	1280	509	2480 - 3010	-131	11.6 - 9.6	
90	2286	1829	1372	546	2660 - 3230	-140	11.6 - 9.6	
100	2540	2032	1524	606	2960 - 3590	-156	11.6 - 9.6	
120	3048	2438	1829	728	3570 - 4320	-187	11.5 - 9.6	
150	3810	3048	2286	909	4470 - 5410	-234	11.5 - 9.5	
180	4572	3658	2743	1091	5370 - 6510	-280	11.5 - 9.5	
200	5080	4064	3048	1213	5970 - 7230	-311	11.5 - 9.5	
210	5334	4267	3200	1273	6270 - 7600	-327	11.5 - 9.5	
240	6096	4877	3658	1455	7180 - 8690	-374	11.5 - 9.5	
270	6858	5486	4115	1637	8080 - 9780	-420	11.5 - 9.5	
300	7620	6096	4572	1819	8980 - 10870	-467	11.5 - 9.5	

WARNING

- * Installing your projector on the ceiling must be done by a qualified technician. Contact your dealer for more information.
- * Do not attempt to install the projector yourself.
- Only use your projector on a solid, level surface. If the projector falls to the ground, you can be injured and the projector severely damaged.
- Do not use the projector where temperatures vary greatly. The projector must be used at temperatures between 41°F (5°C) and 104°F (40°C). (Eco mode selected automatically at 95° to 104°F/35° to 40°C. Operational temperatures during use of wireless LAN card: 41° to 95°F / 5° to 35°C).
- Do not expose the projector to moisture, dust, or smoke. This will harm the screen image.
- Ensure that you have adequate ventilation around your

projector so heat can dissipate. Do not cover the vents on the side or the front of the projector.

Reflecting the Image

Using a mirror to reflect your projector's image enables you to enjoy a much larger image when a smaller space is required. Contact your dealer if you need a mirror system. If you're using a mirror system and your image is inverted, use the MENU and SELECT buttons on your projector cabinet or your remote control to correct the orientation. (→ page 84)

② Making Connections

Connecting Your PC or Macintosh Computer

NOTE: When using with a notebook PC, be sure to connect the projector and notebook PC while the projector is in standby mode and before turning on the power to the notebook PC.

In most cases the output signal from the notebook PC is not turned on unless connected to the projector before being powered up.

** If the screen goes blank while using your remote control, it may be the result of the computer's screen-saver or power management software.*

Enabling the computer's external display

Displaying an image on the notebook PC's screen does not necessarily mean it outputs a signal to the projector.

When using a PC compatible laptop, a combination of function keys will enable/disable the external display.

Usually, the combination of the 'Fn' key along with one of the 12 function keys gets the external display to come on or off. For example, laptops use Fn + F3, while Dell laptops use Fn + F8 key combinations to toggle through external display selections.

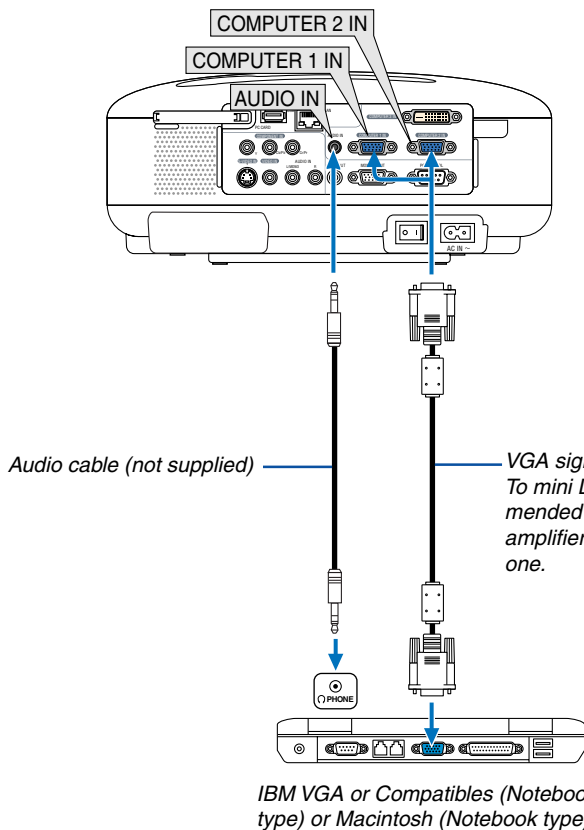

NOTE: The COMPUTER 1 IN connector supports Plug & Play (DDC2).

NOTE: For older Macintosh, use a commercially available pin adapter (not supplied) to connect to your Mac's video port.

NOTE: The 8775 /8774 is not compatible with video decoded outputs of the ISS-6010 switchers.

NOTE: An image may not be displayed correctly when a Video or S-Video source is played back via a commercially available scan converter.

This is because the projector will process a video signal as a computer signal at the default setting. In that case, do the following.

- * When an image is displayed with the lower and upper black portion of the screen or a dark image is not displayed correctly:
Project an image to fill the screen and then press the AUTO ADJ button on the remote control or the AUTO ADJUST button on the projector cabinet.*
- * When noise appears on the sides of the screen:
Use the Overscan feature to display the image correctly.
Be sure to change the Overscan to 0% before pressing the AUTO ADJ or AUTO ADJUST button, otherwise an image may be displayed with its sides cut off.*

2. Installation and Connections

When Viewing a DVI Digital Signal

To project a DVI digital signal, be sure to connect the PC and the projector using a DVI-D signal cable (not supplied) before turning on your PC or projector. Turn on the projector first and select DVI (DIGITAL) from the source menu before turning on your PC.

Failure to do so may not activate the digital output of the graphics card resulting in no picture being displayed. Should this happen, restart your PC.

Do not disconnect the DVI-D signal cable while the projector is running. If the signal cable has been disconnected and then re-connected, an image may not be correctly displayed. Should this happen, restart your PC.

NOTE:

- Use a DVI-D cable compliant with DDWG (Digital Display Working Group) DVI (Digital Visual Interface) revision 1.0 standard. The DVI-D cable should be within 10 m (394") long.
- The DVI (DIGITAL) connector (COMPUTER 3) accepts VGA (640x480), SVGA (800x600), 1152x864, XGA (1024x768) and SXGA (1280x1024 @ up to 60Hz).

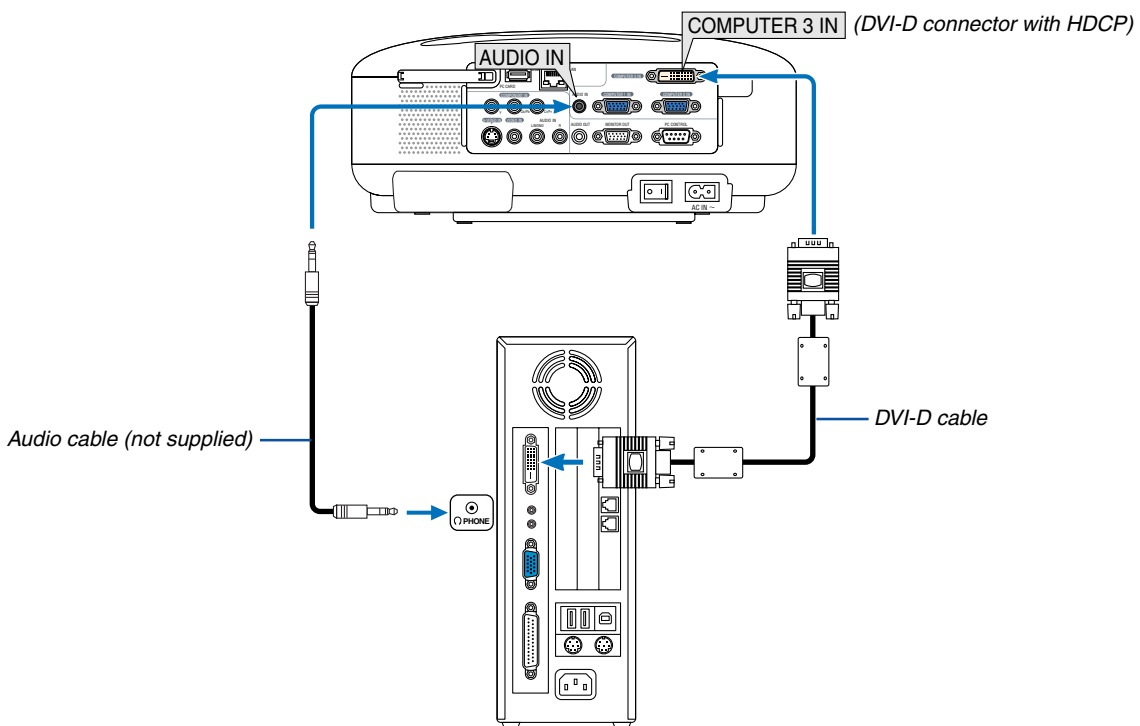

IBM VGA or Compatibles or Macintosh

What is HDCP/HDCP technology?

HDCP is an acronym for High-bandwidth Digital Content Protection. High bandwidth Digital Content Protection (HDCP) is a system for preventing illegal copying of video data sent over a Digital Visual Interface (DVI).

If you are unable to view material via the DVI input, this does not necessarily mean the projector is not functioning properly. With the implementation of HDCP, there may be cases in which certain content is protected with HDCP and might not be displayed due to the decision/intention of the HDCP community (Digital Content Protection, LLC).

To connect SCART output (RGB)

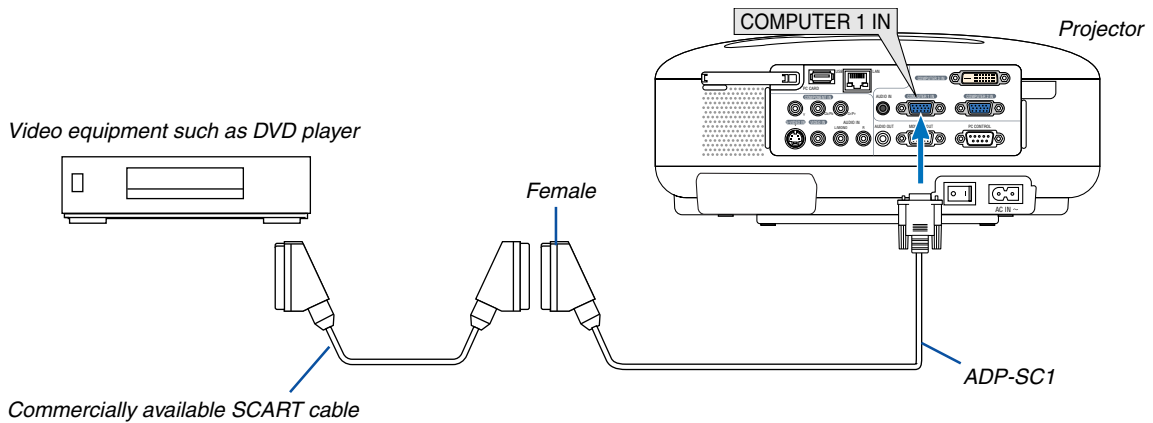

Before connections: An exclusive SCART adapter (ADP-SC1) and a commercially available SCART cable are required for this connection.

From the menu, select [Setup] → [Options] → [Signal Select] → [Computer 1] → [Scart].

SCART is a standard European audio-visual connector for TVs, VCRs and DVD players. It is also referred to as Euro-connector.

NOTE: Audio signal is not available for this connection.

TIP: The ADP-SC1 SCART adapter is obtainable from your dealer in Europe. Contact your dealer in Europe for more information.

Connecting an External Monitor

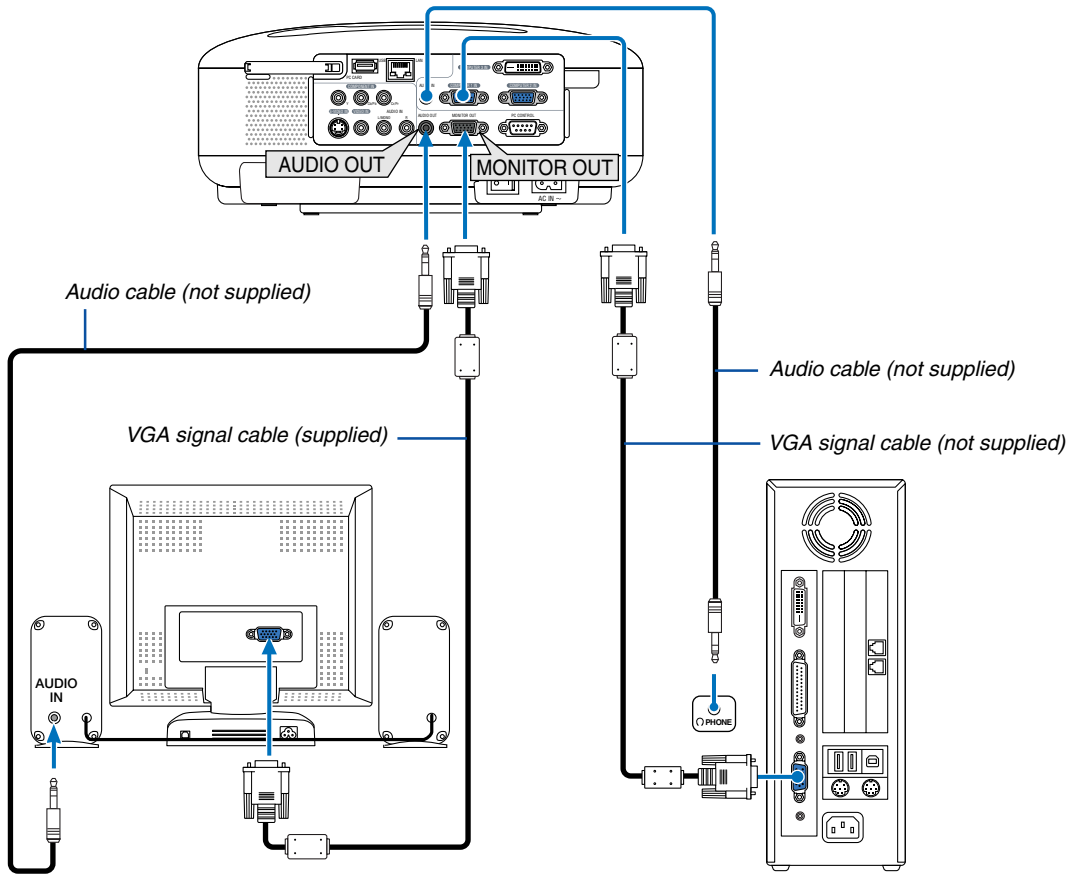

You can connect a separate, external monitor to your projector to simultaneously view on a monitor the RGB analog image you're projecting.

NOTE:

- The **MONITOR OUT** connector will output no sound when the projector is in standby mode.
- The **MONITOR OUT** connector will output no signal when [Power-saving] is selected in [Standby Mode] from the menu.
- When the projector is in the standby mode, the image may not be correctly displayed while the cooling fans are running immediately after turning on or off the power.
- The **AUDIO OUT** jack cannot be used as a headphone jack.
- Output sound level can be adjusted in accordance with the sound level.
- When audio equipment is connected, the projector speaker is disabled.
- Daisy chain connection is not possible.

Connecting Your DVD Player with Component Output

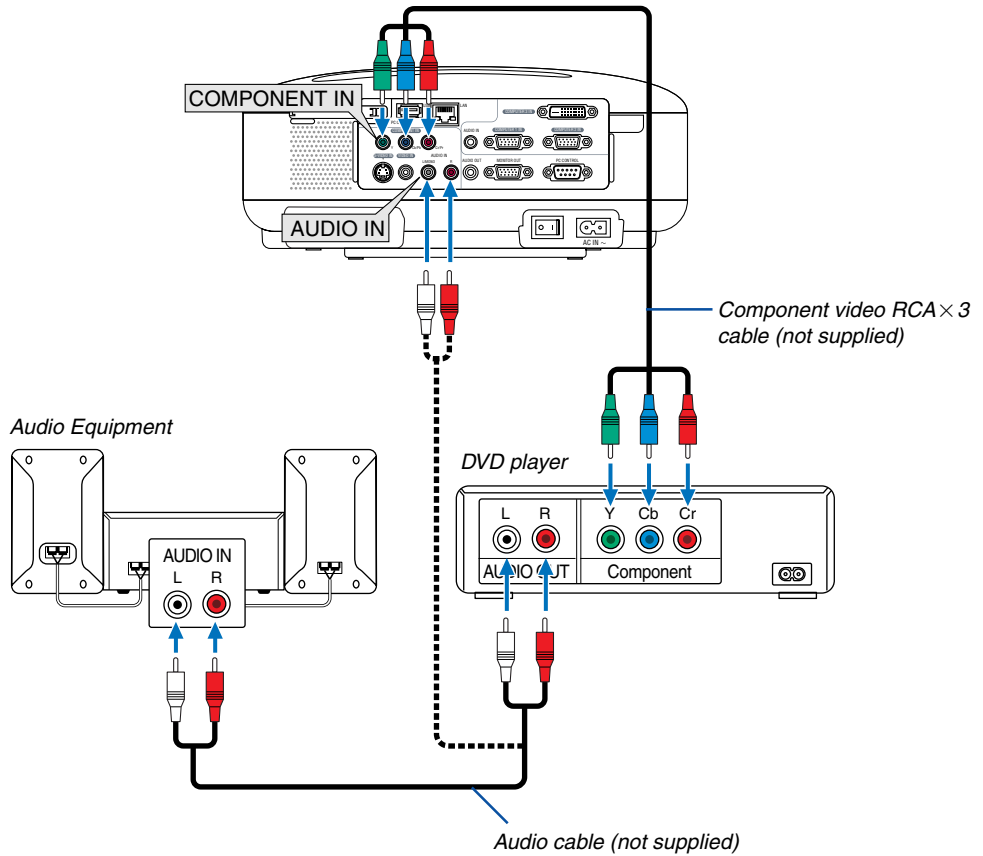

You can connect a video cable to the "Y" connector of the COMPONENT connectors to display a VCR source. To do so, from the menu, select [Setup] → [Options] → [Signal Select] → [Component] → [Video].

NOTE: Refer to your DVD player's owner's manual for more information about your DVD player's video output requirements.

Connecting Your VCR or Laser Disc Player

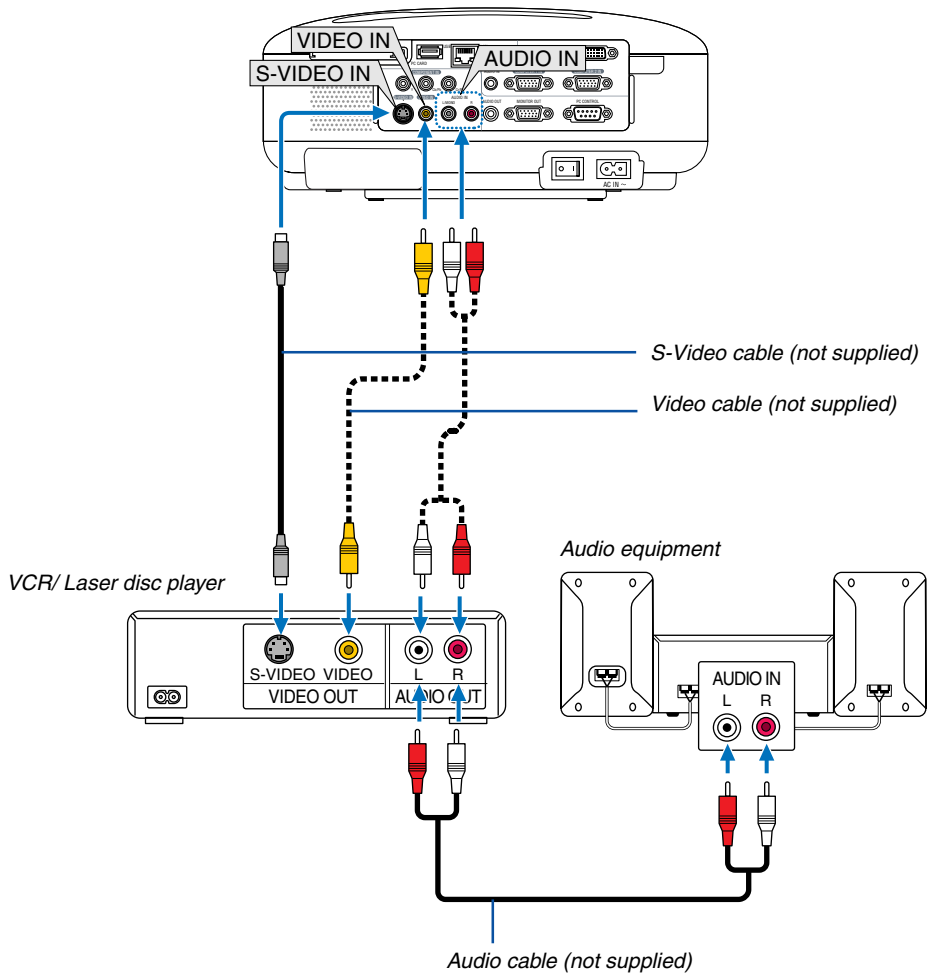

NOTE: Refer to your VCR or laser disc player owner's manual for more information about your equipment's video output requirements.

NOTE: An image may not be displayed correctly when a Video or S-Video source is played back in fast-forward or fast-rewind via a scan converter.

Connecting to a Network

The 8774/8775 comes standard with a LAN port (RJ-45) which provides a LAN connection using a LAN cable. Placing the optional wireless LAN card (NWL-100*) in the PC card slot of the projector also provides a wireless LAN connection. To use a LAN connection, you are required to assign an IP address to the projector. For setting the LAN mode, see page 86 (From the menu, select [Setup] → [Installation] → [LAN Mode])

With the LAN connection, two features are available: Projector control and Picture transmission.

Projector control feature

With the wired or wireless LAN connection, you can control (power on/off, input select, etc.) and receive information from the projector over the network using a computer. The following two methods are available:

- * Using the HTTP Server feature on the projector. (→ page 48)
- * Using PC Control Utility 3.0 from the supplied User Supportware 3 CD-ROM.

Picture transmission feature

With the wired or wireless LAN connection, you can send images and slides from a personal computer to the projector which then can be projected on the screen. The following two methods are available:

- * Using Image Express Utility 2.0 from the supplied User Supportware 3 CD-ROM.
- * Using Ulead Photo Explore 8.0 from the supplied User Supportware 3 CD-ROM.

With the USB mouse connected to the projector, you can also operate the desktop screen on your Windows PC connected to the LAN or the wireless LAN.

- * Using Desktop Control Utility 1.0 from the supplied User Supportware 3 CD-ROM.

NOTE: Use a wireless LAN card conforming to the Wi-Fi standard for your personal computer.

TIP: Five Windows software programs (Image Express Utility 2.0, Desktop Control Utility 1.0, Ulead Photo Explorer 8.0, Viewer PPT Converter and PC Control Utility 3.0) and a Macintosh software program (Image Express Utility 2 for Mac OS X) are contained on the supplied Projector User Supportware 3 CD-ROM. For their functions and operations, see the user's guides (PDF) contained on the same CD-ROM.

Example of LAN connection

(A) Example of wired LAN connection

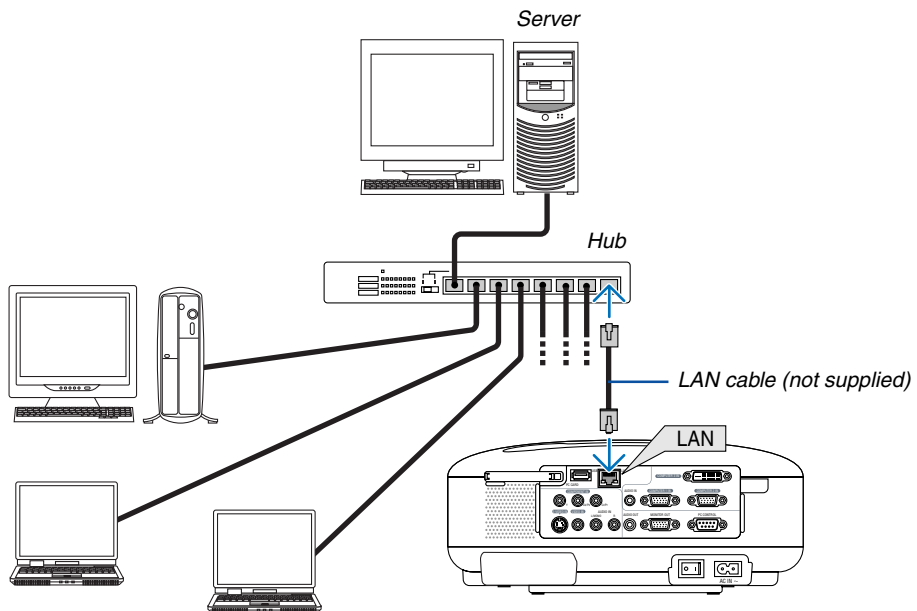

(B) Example of wireless LAN connection
(Network Type → Mode: Infrastructure)

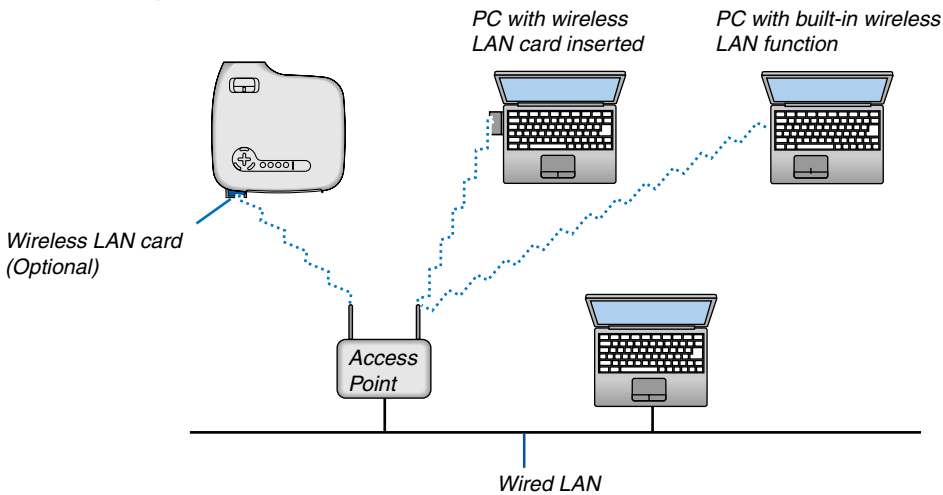

To make connection with a wired LAN via an access point, you need to select the Infrastructure mode. From the menu, select [Setup] → [Installation] → [LAN Mode] → [PC Card] → [Advanced] → [Network Type] → [Mode] → [Infrastructure].

(C) Example of wireless LAN connection (Network Type → Mode: 802.11 Ad Hoc)

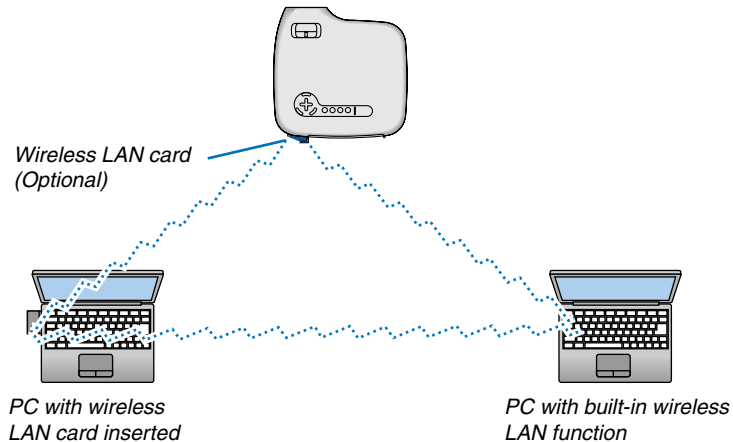

To enable direct communication (i.e., peer-to-peer) between personal computers and projectors, you need to select the 802.11 Ad Hoc mode.

From the menu, select [Setup] → [Installation] → [LAN Mode] → [PC Card] → [Advanced] → [Network Type] → [Mode] → [802.11 Ad Hoc].

The 802.11 Ad Hoc mode complies with IEEE802.11 standard.

When in Ad Hoc mode, only 802.11b is available for communication method. Data transmission speed in Ad Hoc mode is limited up to 11Mbps.

Inserting and Removing a PC Card

To insert the optional wireless LAN card or a PC memory card (also referred to as PC card in this manual), follow the steps below.

CAUTION:

- * Direction for Inserting the PC Card
The PC card has a top and bottom and must be inserted into the PC card slot in a specific direction. It cannot be inserted backwards or upside-down.
Attempting to force it into the slot in the wrong direction may break the internal pin and damage the card slot. Refer to the PC card's operating instructions for the proper direction of insertion.
- * Back up your PC card's data in case it will need to be restored.
- * To prevent electrostatic discharge damage to the wireless LAN card, wear an anti-static wrist strap. If no wrist strap is available, ground yourself by touching metal such as a door knob.

A dummy card is inserted into the PC CARD slot at the time of shipment. First remove the dummy cards before use.

Inserting the PC Card

1. Make sure the main power is off before inserting the PC card. (This step is needed only when the wireless LAN card being inserted into the projector's PC CARD slot)

2. Hold the PC card horizontally and insert it slowly into the PC card slot with its top facing up.

The eject button pops out once the PC card is fully inserted. Check that the PC card is fully inserted.

NOTE: Do not try to force the PC card into the slot or you may bend the pins inside the slot.

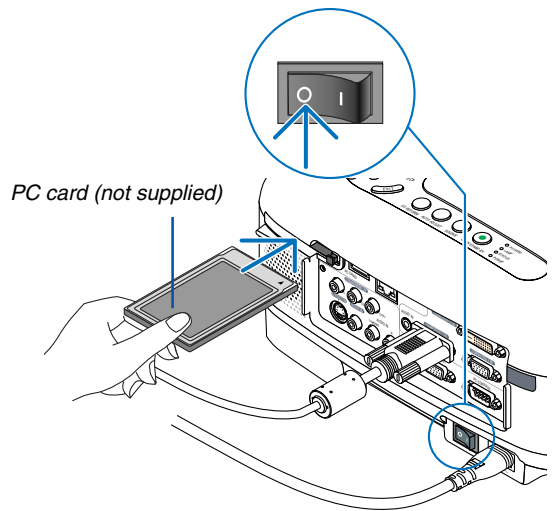

PC Card Lock

The supplied PC card lock prevents a PC card or an optional wireless LAN card from being ejected during use. Some PC cards cannot be used based on their size and shape. Use the supplied screw to fix the PC card lock.

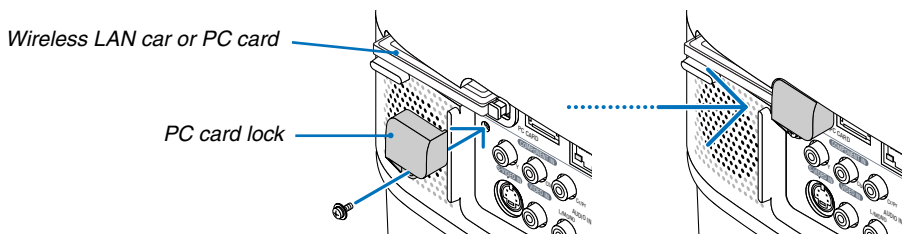

2. Installation and Connections

Removing the PC Card

1. **Make sure that the PC CARD access indicator is not lit. (This step is needed only when the PC memory card being inserted into the projector's PC CARD slot.)**

NOTE: The PC CARD access indicator lights while its data is being accessed.

2. **To remove the wireless LAN card, make sure that the main power is off. (This step is needed only when the wireless LAN card being inserted into the projector's PC CARD slot)**
3. **Press the eject button. The PC card pops out a little. Grasp the edges of the PC card and pull it out.**

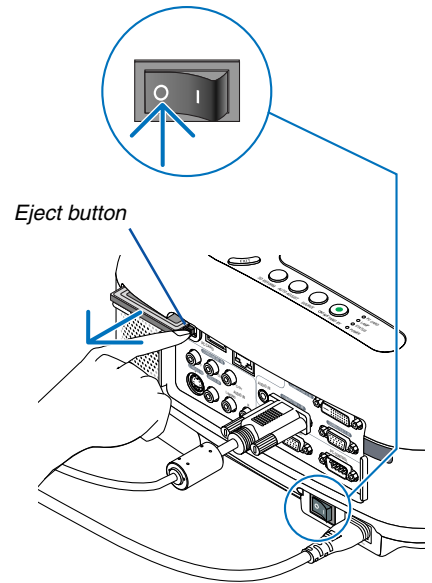

PC Card Type

The PC Card slot accepts PCMCIA Type II only.

NOTE: The projector does not support NTFS formatted flash memory card or USB memory device.

Be sure to use a flash memory card or USB memory device formatted with the FAT32, FAT16 or FAT file system.

To format your flash memory card or USB memory device in your computer, refer to the document or help file that comes with your Windows operating systems.

Connecting the Supplied Power Cable

Connect the supplied power cable to the projector.

First connect the supplied power cable's two-pin plug to the AC IN of the projector, and then connect the other plug of the supplied power cable in the wall outlet.

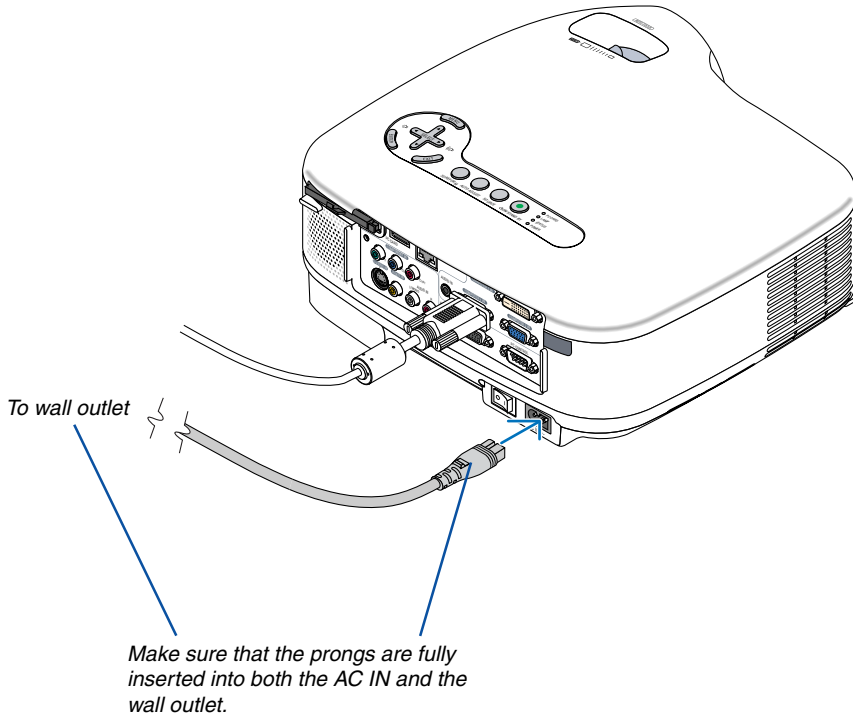

CAUTION:

Do not unplug the power cable from the wall outlet under any one of the following circumstances. Doing so can cause damage to the projector or PC card:

- While the projector's lamp is lighted.
- While the cooling fans are running. The cooling fans continue to work for 30 seconds after the projector is turned off.
- While the PC CARD Access Indicator lights. Doing so can damage your PC memory card.

3. Projecting an Image (Basic Operation)

This section describes how to turn on the projector and to project a picture onto the screen.

1 Turning on the Projector

NOTE:

- The projector has two power switches: a main power switch and a POWER (ON/STAND BY) button (POWER ON and OFF on the remote control).
- When plugging in or unplugging the supplied power cable, make sure that the main power switch is pushed to the off (O) position. Failure to do so may cause damage to the projector.
- The projector has a feature to prevent itself from being used by unauthorized individuals. To use this feature, register a keyword. (→ page 42)

1. To turn on the main power to the projector, press the Main Power switch to the on position (I).

- The POWER indicator will light orange. See the Power Indicator section on page 107 for more details.

2. Remove the lens cap.

3. Press the POWER (ON/STAND BY) button on the projector cabinet or POWER ON button on the remote control for a minimum of 2 seconds when the power indicator turns a steady green, and the projector is ready to use.

- After you turn on your projector, ensure that the computer or video source is turned on and that your lens cap is removed.

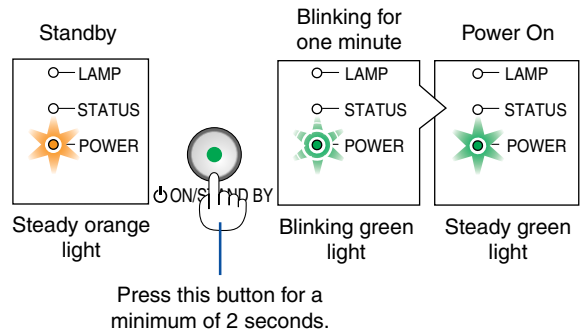
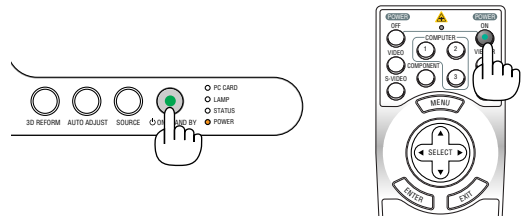
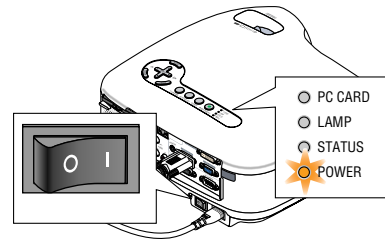

(→ page 107)

NOTE: When no signal is available, a blue, black or logo screen is displayed.

3. Projecting an Image (Basic Operation)

Note on Startup screen (Menu Language Select screen)

When you first turn on the projector, you will get the Startup menu. This menu gives you the opportunity to select one of the 21 menu languages.

To select a menu language, follow these steps:

1. Use the **SELECT ▲ or ▼** button to select one of the 21 languages for the menu.

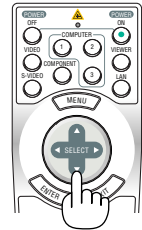
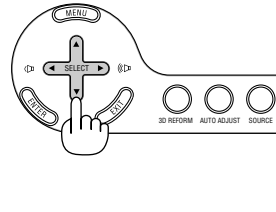
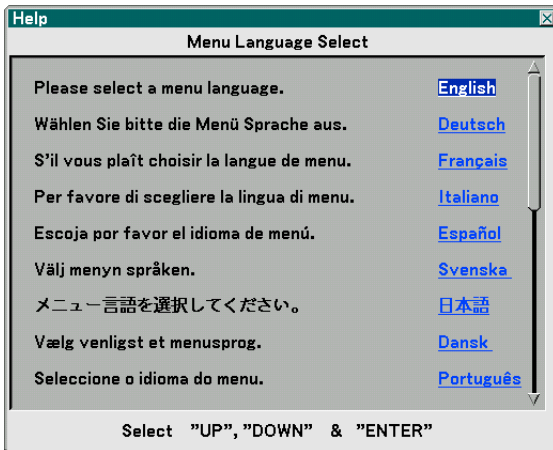

2. Press the **ENTER** button to execute the selection.

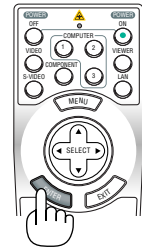
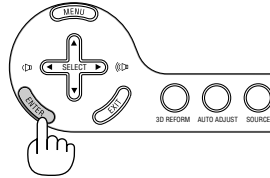

3. To close the menu, press the **EXIT** button.

After this has been done, you can proceed to the menu operation.

If you want, you can select the menu language later. (→ [Language] on page 78)

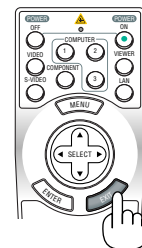
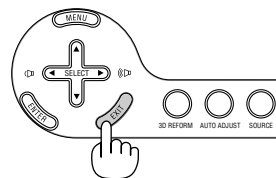

NOTE:

- The projector cannot be turned off for 60 seconds after the lamp is turned on and while the POWER indicator is blinking green.
- Immediately after the lamp is turned off or when the ambient temperature is high, the cooling fans will run for a moment and then you will get an image on the screen.
- Immediately after turning on the projector, screen flicker may occur. This is normal. Wait 3 to 5 minutes until the lamp lighting is stabilized.

- When the Lamp mode is set to Eco, the Lamp indicator will light green.
- If one of the following things happens, the projector will not turn on.
 - If the internal temperature of the projector is too high, the projector detects abnormal high temperature. In this condition the projector will not turn on to protect the internal system. If this happens, wait for the projector's internal components to cool down.
 - When the lamp reaches its end of usable life, the projector will not turn on. If this happens, replace the lamp. (→ page 104)
 - If the lamp fails to light, and if the STATUS indicator flashes on and off in a cycle of six times, wait a full minute and then turn on the power.

② Selecting a Source

Selecting the computer or video source

Using the Remote Control

Press any one of the COMPUTER 1/2/3, Component, VIDEO, S-VIDEO, VIEWER or LAN buttons.

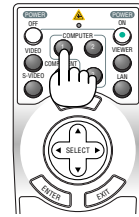

Selecting from Source List

Press and quickly release the SOURCE button on the projector cabinet to display the Source list. Each time the SOURCE button is pressed, the input source will change as follows: "Computer 1/2/3", "Component", "Video" (VCR or laser disc player), "S-Video", "Viewer" (slides on a PC card) or "LAN" (LAN port [RJ-45] or wireless LAN card).

To display the selected source, press the ENTER button.

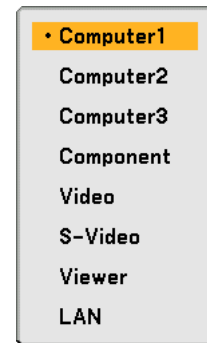
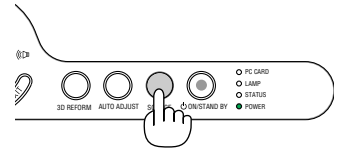

Detecting the Signal Automatically

Press and hold the SOURCE button for a minimum of 1 second, the projector will search for the next available input source. Each time you press and hold the SOURCE button for a minimum of 1 second, the input source will change as follows:

Computer1 → Computer2 → Computer3 → Component → Video → S-Video → Viewer → Computer1 → ...

If no input signal is present, the input will be skipped. When the input source you wish to project is displayed, release the button.

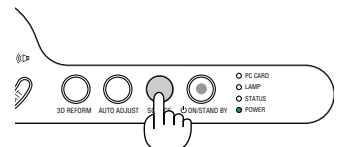

③ Adjusting the Picture Size and Position

Place your projector on a flat level surface and ensure that the projector is square to the screen.

Lift the front edge of the projector to center the image vertically.

If the projected image does not appear square to the screen, use the Keystone feature for proper adjustment. (→ page 29, 38)

Rotate the front of the projector right or left (to the right in this example) to center the image horizontally on the screen.

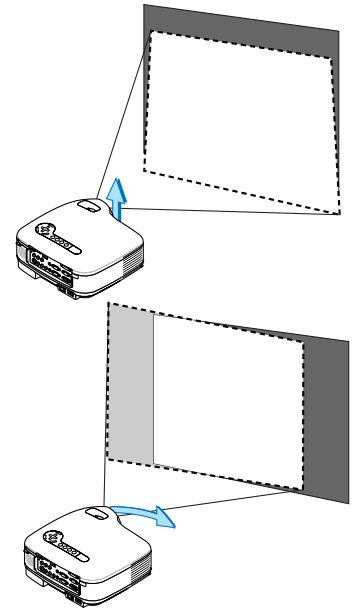

Adjust the Tilt Foot

1. Lift the front edge of the projector.



CAUTION:

Do not try to touch the ventilation outlet during Tilt Foot adjustment as it can become heated while the projector is turned on and during its cool down period after it is turned off.

2. Push up the Adjustable Tilt Foot Levers on the right and left sides of the projector to extend the adjustable tilt feet (maximum height).

3. Lower the front of the projector to the desired height.

4. Release the Adjustable Tilt Foot lever to lock the Adjustable tilt foot.

There is approximately 10 degrees (up) of adjustment for the front of the projector.

TIP: When [Auto Keystone] is turned on, adjusting the height of a projected image or changing projection angle will result in Auto Keystone function to work to quickly correct the vertical distortion. The [Keystone] screen will be displayed.

For operating the [Keystone] screen, see ④ Correcting Keystone Distortion" on page 29.

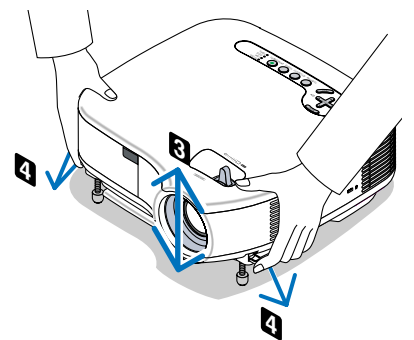
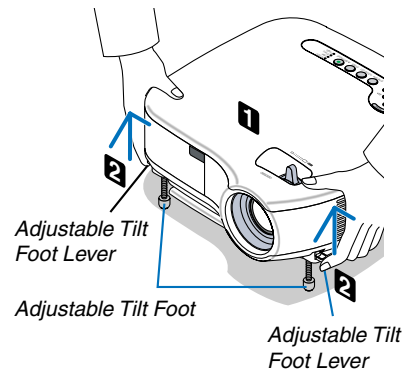
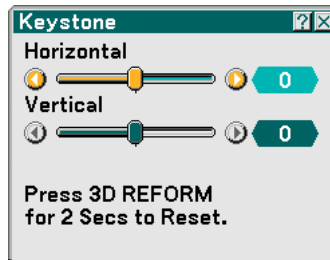

NOTE: Your "Keystone" correction data can be reset by pressing and holding the 3D REFORM button for a minimum of 2 seconds.



CAUTION:

Do not use the tilt-foot for purposes other than originally intended. Misuses such as using the tilt foot to carry or hang (from the wall or ceiling) the projector can cause damage to the projector.

3. Projecting an Image (Basic Operation)

Zoom

Use the ZOOM lever to adjust the image size on the screen.

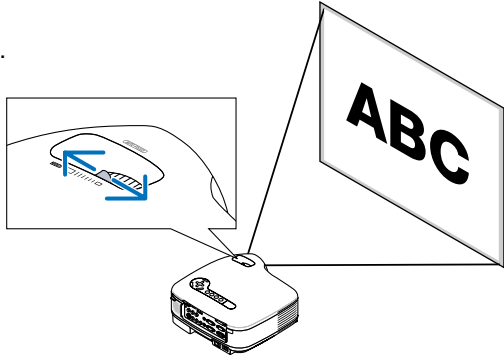

Focus

Use the FOCUS ring to obtain the best focus.

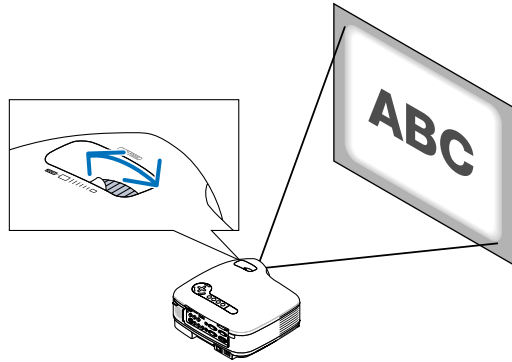

4 Correcting Keystone Distortion

Auto Keystone Correction

The Auto Keystone correction feature will correct vertical distortion of a projected image on the screen. No special operation required. Just put the projector on a flat surface.

To use the Auto Keystone function, first you must select [Auto] in [Keystone] from the menu.



Manual Keystone Correction

You can also correct keystone distortion manually.

To do so:

1. Press the 3D REFORM button on the remote control or the projector cabinet.

The Keystone screen will be displayed on the screen.

- When [Auto] is selected in [Keystone] from the menu, start from step 3.

2. Press the SELECT ▼ button to select [Vertical] and then use the SELECT ◀ or ▶ so that the left and right sides of the projected image are parallel.

* Adjust the vertical keystone distortion.

3. Align the left (or right) side of the screen with the left (or right) side of the projected image.

- Use the shorter side of the projected image as the base.
- In the right example, use the left side as the base.

NOTE: When [Manual] is selected in [Keystone] from the menu, project an image adjusting projector position so that the screen is smaller than the area of the projected image. See page 77 for selecting [Manual] in [Keystone].

4. Press the SELECT ▲ button to select [Horizontal] and then use the SELECT ◀ or ▶ so that the top and bottom sides of the projected image are parallel.

- Adjust the horizontal keystone distortion.

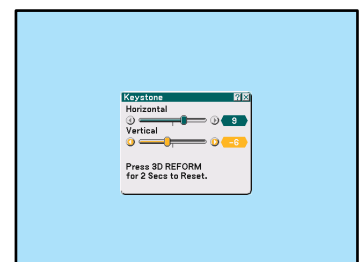
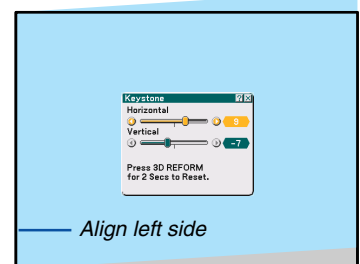
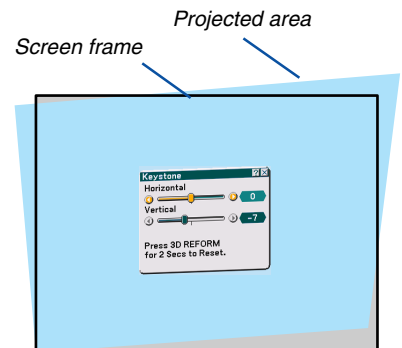
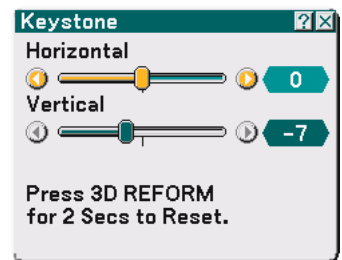

3. Projecting an Image (Basic Operation)

5. Repeat steps 2 and 4 to correct keystone distortion.

6. After completing Keystone correction, press the ENTER button.

The Keystone screen will disappear.

- To perform Keystone correction again, press the 3D REFORM button to display the Keystone screen and repeat above steps 1 to 6.

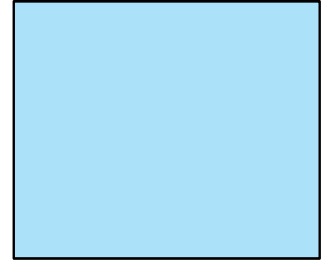

NOTE:

- Turning on the projector will reset the previous correction setting values and correct distortion anew if the projection angle is changed from the last use.
If the projection angle is the same as in the last use, the previous correction setting values are retained in the memory.
To use the previous correction setting values after changing projection angle, select [Manual] in [Keystone] from the menu.
(→ page 77)
 - To reset the 3D Reform correction setting values, press and hold the 3D REFORM button for a minimum of 2 seconds.
 - Each time the 3D REFORM button is pressed, the item will change as follows: Keystone → Cornerstone → None → Keystone → ...
For information on [Cornerstone], see "Correcting Horizontal and Vertical Keystone Distortion (Cornerstone) on page 38.
 - The 3D Reform feature can cause an image to be slightly blurred because the correction is made electronically.
-

5 Optimizing an RGB Image Automatically

Adjusting the Image Using Auto Adjust

Optimizing an RGB image automatically.

Press the Auto Adjust button to optimize an RGB image automatically.

This adjustment may be necessary when you connect your computer for the first time.

[Poor picture]

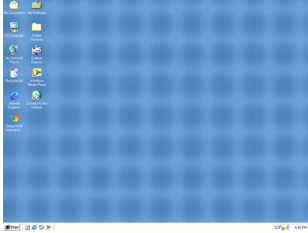

[Normal picture]

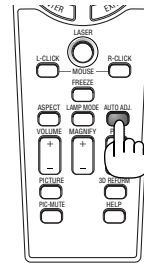
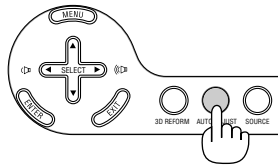
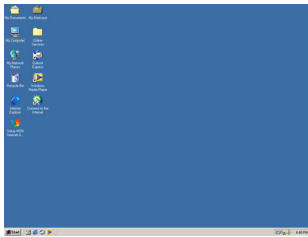

NOTE:

- Some signals may take time to display or may not be displayed correctly.
- The Auto Adjust function does not work for component or video signals.
- If the Auto Adjust operation cannot optimize the RGB signal, try to adjust Clock and Phase manually. (→ page 72)

6 Adjusting Volume Up & Down

Sound level from the speaker and the AUDIO OUT jack (Stereo mini) on the projector can be adjusted.

NOTE: When no menus appear, the SELECT ◀▶ buttons on the projector cabinet work as a volume control.

Increase volume

Decrease volume

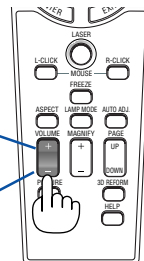

7 Using the Laser Pointer

You can use the laser to draw your audience's attention to a red dot that you can place on any object.



CAUTION:

- Do not look into the laser pointer while it is on.
- Do not point the laser beam at a person.
- Do not allow children to use the laser pointer.

Press and hold the LASER button to activate the laser pointer.

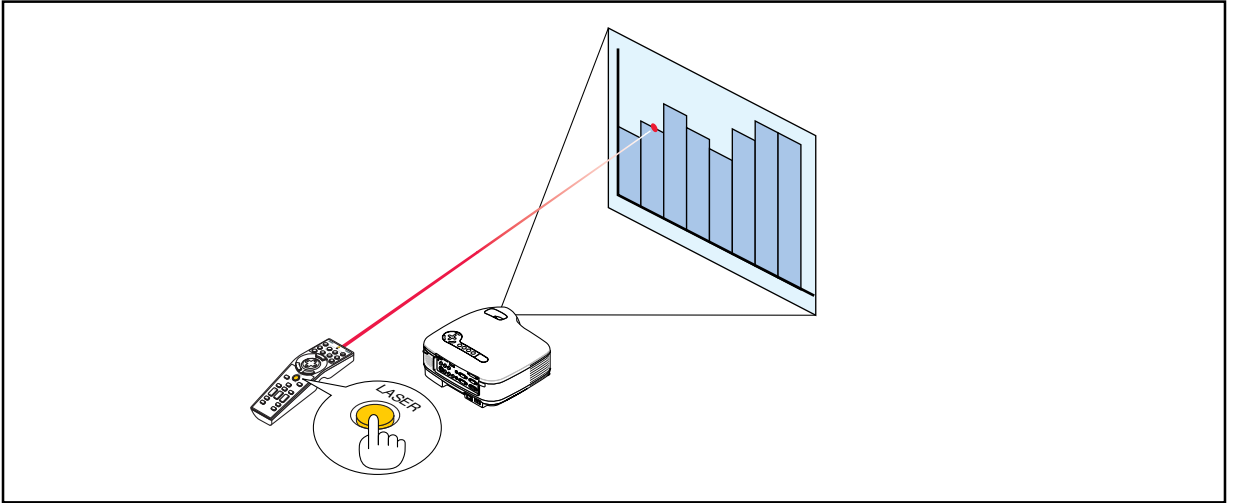

Setting the function switch

There are two switches on the bottom of the battery case: an applicable projector selector switch (1) and laser enable/disable switch (2). Check the projector being used and decide whether to enable or disable laser, then set these switches as necessary using the tip of a thin ball-point pen. On this model, an applicable projector selector switch (1) is not used.

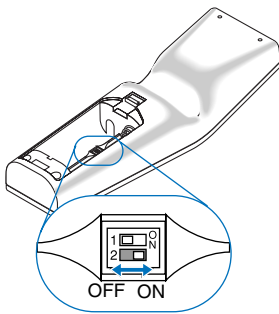

Switch (2)

On Enabled (the laser lights when the LASER button is pressed) [Factory default]

Off Disabled (the laser does not light even when the LASER button is pressed)

Disable the laser when using in an environment in which the unit is accessible to children.

8 Turning off the Projector

To turn off the projector:

1. Press the **POWER (ON/STAND BY)** button on the projector cabinet or the **POWER OFF** button on the remote control. The [Power Off / Are you sure?] message will appear.

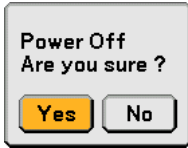

2. Press the **ENTER** button or the **POWER (ON/STANDBY)** or the **POWER OFF** button again.

The power indicator will glow orange. After the projector turns off, the cooling fans keep operating for 30 seconds (Cooling-off time).

NOTE: Immediately after turning on the projector and displaying an image, you cannot turn off the projector for 60 seconds.

3. Turn off the Main Power switch. The power indicator will go out.

CAUTION

Do not unplug the power cable from the wall outlet or do not turn off the main power under any one of the following circumstances.

Doing so can cause damage to the projector or PC card:

- While the projector lamp is lit.
- While the cooling fans are running. (The cooling fans continue to work for 30 seconds after the projector is turned off).
- While the PC CARD Access Indicator lights. Doing so can damage your PC memory card.

9 After Use

Preparation: Make sure that the main power is turned off.

1. Unplug the power cable.
2. Disconnect any other cables.
3. Retract adjustable tilt feet if extended.
4. Cover the lens with the lens cap.
5. Put the projector and accessories in the supplied soft case.

NOTE: Before putting the projector in the soft case, be sure to retract the feet. Failure to do so may cause the damage to the projector.

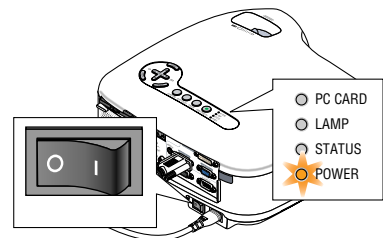
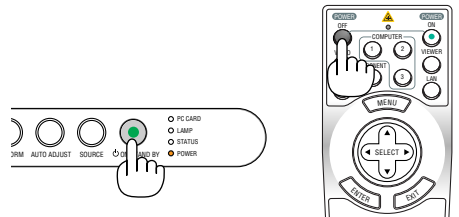
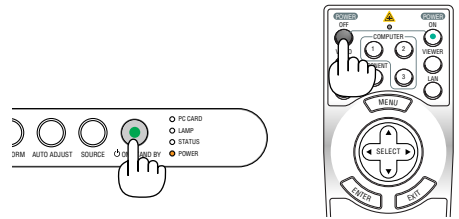

4. Convenient Features

1 Turning Off the Image and Sound

Press the PIC-MUTE button to turn off the image and sound for a short period of time. Press again to restore the image and sound.

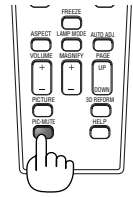

2 Freezing a Picture

Press the FREEZE button to freeze a picture. Press again to resume motion.

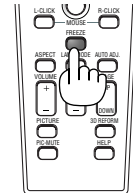

3 Enlarging and Moving a Picture

You can enlarge the area you want up to 400 percent.

To do so:

1. Press the MAGNIFY (+) button.

Each time the MAGNIFY (+) button is pressed, the image is magnified.

* Image can be magnified up to 400%

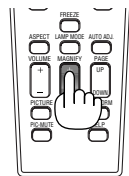
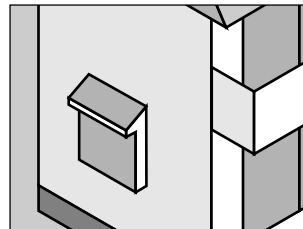

2. Press the SELECT ▲▼◀▶ button.

The area of the magnified image will be moved

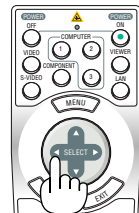

3. Press the MAGNIFY (-) button.

Each time the MAGNIFY (-) button is pressed, the image is reduced.

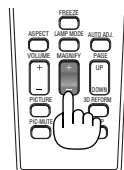
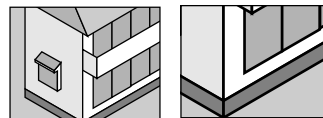

4 Changing Lamp Mode

The lamp life can be extended by using the Eco mode.

To change to the [Eco] mode, do the following:

1. Press the LAMP MODE button to display [Lamp Mode] screen.

2. Use the SELECT ▲ or ▼ button to select [Eco] mode.

3. Press the ENTER button. Or press the SELECT ▶ button to select [OK] and press the ENTER button.

To cancel it, select [Cancel] and press the ENTER button.

To change from [Eco] to [Normal], Go back to Step 2 and select [Normal]. Repeat Step 3.

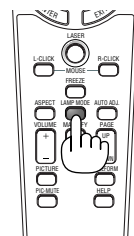

5 Getting Integrated Help

You get the contents about Help in English, German and Japanese.

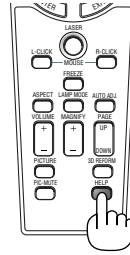

Display Help

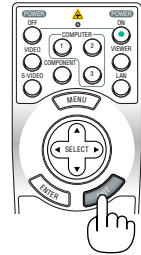

Exit Help

6 Using a USB Mouse

Using a USB mouse gives you a smooth operation. A commercially available USB mouse can be used.

NOTE: There may be some brands of a USB mouse that the projector does not support.

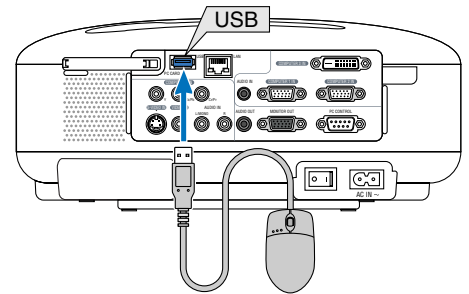

Operate the Menus using the USB mouse

Mouse Cursor

When connecting a USB mouse to the projector, you get a mouse cursor on the screen. Unless you use your USB mouse within 10 seconds, the mouse cursor disappears.

NOTE: You can change the shape of the mouse cursor. To do so, select the menu → [Setup] → [Tools] → [Mouse] → [Mouse Pointer].

Menu Display

Clicking with the left mouse button displays the menu. To close the menu, click anywhere in the background.

Adjusting and Setting Display

You can select a menu item and click with the left mouse button to make adjustments and settings.

Using the middle button on the mouse

The projector supports the middle button on your mouse. With the middle button you can do the following:

- You can use a scroll bar in the menu or the help.
- You can click the middle button to display or hide the ChalkBoard toolbar.

Example:

Click (or press and hold) the left mouse button on the ◀ or ▶ to adjust the brightness. Or click and drag the left mouse button on the slide bar horizontally to adjust it.

To save the adjustments, click . The display is closed.



- Click  with the left mouse button to display a description of the selected menu item.
- Click and drag the title bar with the left mouse button to move the adjustment or setting dialog box.

7 Using Remote Mouse Receiver

The remote mouse receiver enables you to operate your computer's mouse functions from the remote control. It is a great convenience for your computer-generated presentations.

Connecting the remote mouse receiver to your computer

If you wish to use the remote mouse function, connect the mouse receiver and computer. The mouse receiver can be connected directly to the computer's USB port (type A).

NOTE: Depending on the type of connection or OS installed on your computer, you may have to restart your computer or change your computer settings.

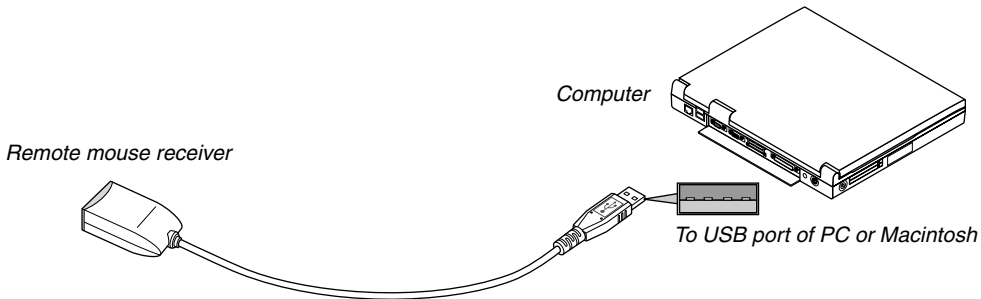

When operating a computer via the remote mouse receiver

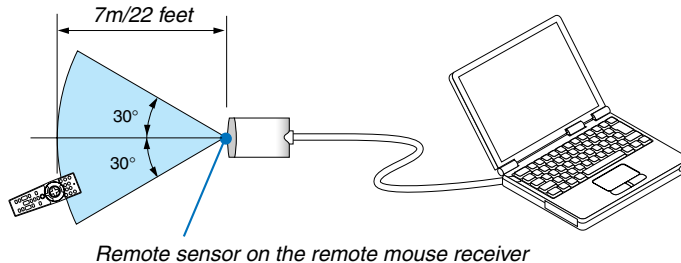

When connecting using the USB port

For PC, the mouse receiver can only be used with a Windows 98/Me/XP*, Windows 2000 or MacOS X 10.0.0 or later operating system.

** NOTE: In SP1 or older version of Windows XP, if the mouse cursor will not move correctly, do the following: Clear the Enhance pointer precision check box underneath the mouse speed slider in the Mouse Properties dialog box [Pointer Options tab].*

NOTE: Wait at least 5 seconds after disconnecting the mouse receiver before reconnecting it and vice versa. The computer may not identify the mouse receiver if it is repeatedly connected and disconnected in rapid intervals.

Operating your computer's mouse from the remote control

You can operate your computer's mouse from the remote control.

PAGE UP/DOWN Button scrolls the viewing area of the window or to move to the previous or next slide in PowerPoint on your computer.

SELECT ▲▼◀▶ Button moves the mouse cursor on your computer.

MOUSE L-CLICK Button works as the mouse left button.

MOUSE R-CLICK Button works as the mouse right button.

NOTE: When you operate the computer using the SELECT ▲▼◀▶ button with the menu displayed, both the menu and the mouse pointer will be affected. Close the menu and perform the mouse operation.

About Drag Mode:

By pressing the MOUSE L-CLICK or R-CLICK button for 2 or 3 seconds then releasing, the drag mode is set and the drag operation can be performed simply by pressing the SELECT ▲▼◀▶ button. To drop the item, press the MOUSE L-CLICK (or R-CLICK) button. To cancel it, press the MOUSE R-CLICK (or L-CLICK) button.

TIP: You can change the Pointer speed on the Mouse Properties dialog box on the Windows. For more information, see the user documentation or online help supplied with your computer.

8 Correcting Horizontal and Vertical Keystone Distortion (Cornerstone)

Use the 3D Reform feature to correct keystone (trapezoidal) distortion to make the top or bottom and the left or right side of the screen longer or shorter so that the projected image is rectangular.

Cornerstone

1. Press and hold the 3D REFORM button for a minimum of 2 seconds to reset current adjustments.
Current adjustments for [Keystone] or [Cornerstone] will be cleared.
2. Project an image so that the screen is smaller than the area of the raster.
3. Pick up any one of the corners and align the corner of the image with a corner of the screen.

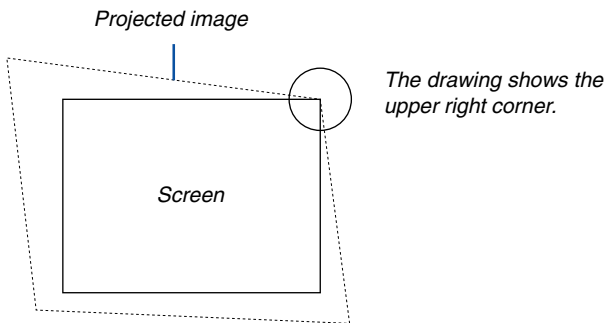

4. Press the 3D REFORM button on the remote control twice.
The Cornerstone adjustment screen is displayed.

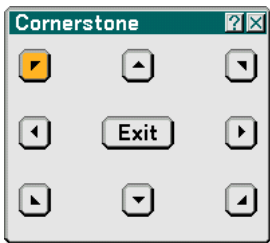

5. Use the SELECT **▲▼◀▶** button to select one icon which points in the direction you wish to move the projected image frame.
6. Press the ENTER button.
7. Use the SELECT **▲▼◀▶** button to move the projected image frame as shown on the example.

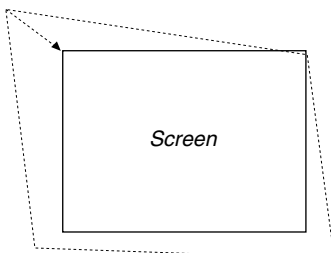

8. Press the ENTER button.

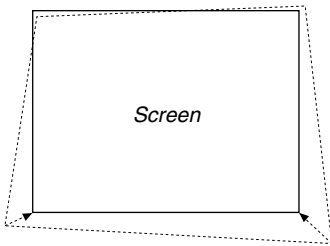

9. Use the SELECT ▲▼◀▶ button to select another icon which points in the direction.

On the Cornerstone adjustment screen, select [Exit] or press the EXIT button on the remote control.

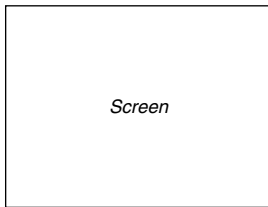

The confirmation screen is displayed.



10. Press the SELECT ◀ or ▶ button to highlight the [OK] and press the ENTER button.

This completes the keystone correction.

Selecting [Cancel] will return to the adjustment screen without saving changes (Step 3).

Selecting [Reset] will return to the factory default.

Selecting [Undo] will exit without saving changes.

NOTE: To reset the 3D Reform correction setting values, press and hold the 3D REFORM button for a minimum of 2 seconds.

NOTE: During 3D Reform adjustment, [Aspect Ratio] and [Screen] may not be available. Should this happen, first reset the 3D Reform data and then do each setting. Second repeat the 3D Reform adjustment. Changing [Aspect Ratio] and/or [Screen] setting can limit [3D Reform] in its adjustable range.

The adjustable ranges for 3D Reform are as follows:

	Horizontal	Vertical
Cornerstone	Max. +/- 35° approx.	Max. +/- 40° approx.
Keystone	Max. +/- 27° approx.	

* The following are conditions under which the maximum angle is achieved:

- Image is projected in Wide (Zoom lever)
- Resolution is XGA
Higher resolution than XGA narrows the adjustable range.
- Menu items should be set as follows:
Aspect Ratio 4:3
Screen Type 4:3
- Horizontal and Vertical are adjusted separately.
A combination of both adjustments narrows the adjustable range.
- When [4:3 Fill] is selected in [Aspect Ratio], [Cornerstone] and "Horizontal Keystone" are not available.

NOTE:

- If the Cornerstone screen is unavailable (grayed), press and hold the 3D REFORM button for a minimum of 2 seconds to reset the current correction data. The Cornerstone function becomes available.
 - Turning on the projector will reset the previous correction setting values and correct distortion anew if the projection angle is changed from the last use.
If the projection angle is the same as in the last use, the previous correction setting values are retained in the memory.
To use the previous correction setting values after changing projection angle, select [Manual] in [Keystone] from the menu. (→ page 77)
-

NOTE: Using 3D Reform correction can cause the image to be slightly blurred because the correction is made electronically.



9 Making Freehand Drawings on a Projected Image (ChalkBoard)

The ChalkBoard feature allows you to write and draw messages on a projected image.

NOTE: The ChalkBoard feature is available only when a USB mouse is used.

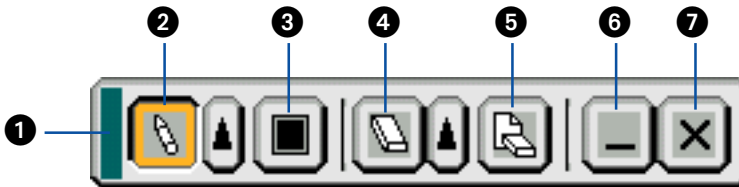
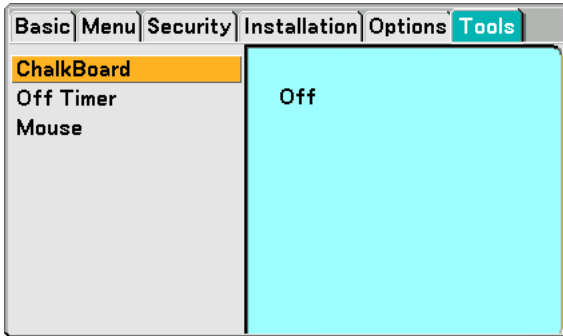
To display the ChalkBoard tool bar, click the middle button on your mouse or select [ChalkBoard] from the menu. The tool bar contains the following icons.



- ① Drag Drags to move the tool bar.
- ② Pen Left-click and drag to draw. Left-click  or right-click the pen icon to display the pen palette containing four lines of different thickness from which you can select a line you prefer by left-clicking.
- ③ Color Selects a color. Left-click to display the color palette from which you can select a color you prefer by left-clicking.
- ④ Eraser Left-click and drag to erase part of a drawing. Left-click  or right-click the eraser icon to display the eraser palette containing four erasers of different thickness from which you can select an eraser you prefer by left-clicking.
- ⑤ Clear Left-click to clear the drawing completely from the ChalkBoard screen.
- ⑥ Hide Hides the tool bar by left-clicking. Right-clicking anywhere on the screen displays the ChalkBoard tool bar again.
- ⑦ Exit Clears the complete drawing and exits the ChalkBoard.

NOTE:

- The menu is not available while you display the ChalkBoard screen.
- Selecting another source or switching slides in the Viewer clears a drawing completely.

10 Preventing Unauthorized Use of the Projector

Assigning a keyword prevents the projector from being used by unauthorized individuals.

Assigning a Keyword for the first time

1. Press the **MENU** button.

The menu will be displayed.

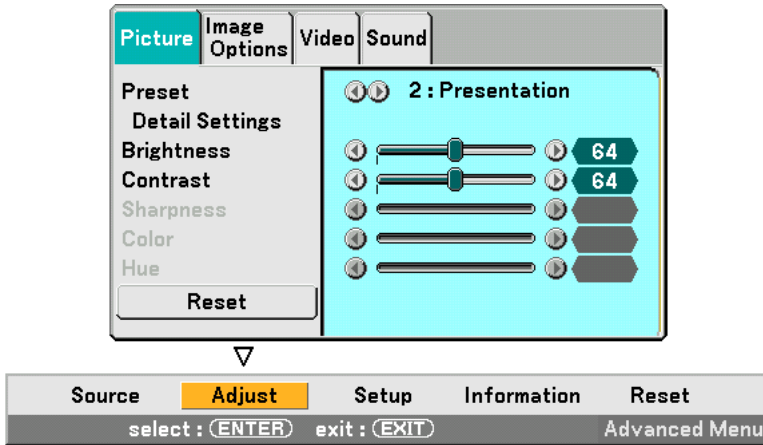

2. Press the **SELECT** ► button to highlight the [Setup] submenu and press the **ENTER** button.

The page tab [Basic] will be highlighted.

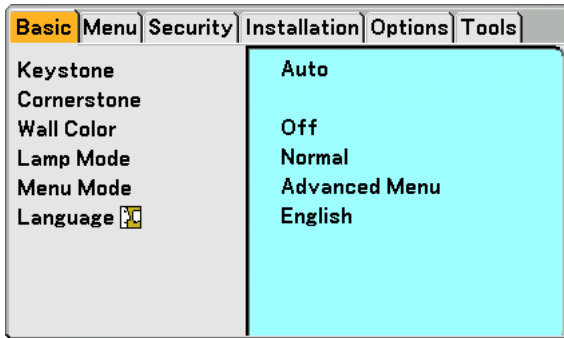

3. Press the **SELECT** ► button twice to highlight the page tab [Security].

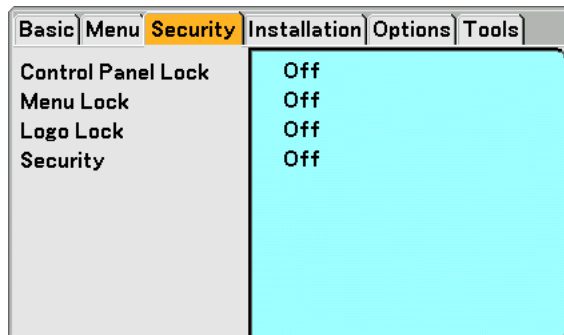

4. Press the **SELECT ▼** button four times to highlight [Security].

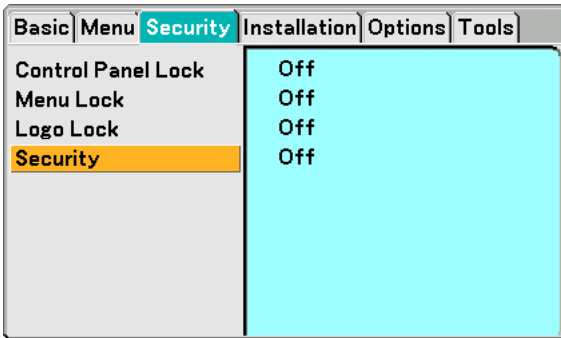

5. Press the **ENTER** button to display the Security screen.

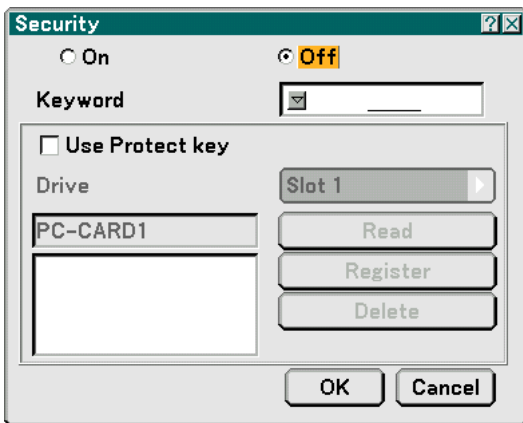

6. Press the **SELECT ▼** button once to highlight the Keyword entry box and press the **ENTER** button. The Software keyboard will be displayed.

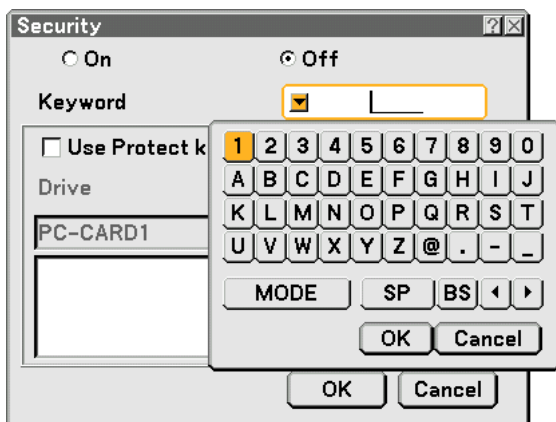

7. Enter an alphanumeric keyword using the Software keyboard

For example, to enter “1234”, follow the steps 7-1 to 7-4 below.

NOTE:

- Please make a note of your keyword.
- Do not use spaces (SP) in your keyword.

7-1. Highlight the number “1” and press the ENTER button.

The asterisk “*” will be displayed in the Keyword entry box.

7-2. Press the SELECT ► button once to highlight “2” and press the ENTER button.

The asterisk “**” will be displayed in the Keyword entry box.

7-3. For “3” and “4”, use the same procedure as step 7-2.

The asterisk “****” will be displayed in the Keyword entry box.

7-4. Press the SELECT ▼ button to highlight [OK] and press the ENTER button.

The Software keyboard will disappear.

8. Press the SELECT ▲ button once to highlight [Off] and press the SELECT ◀ button to highlight [On].

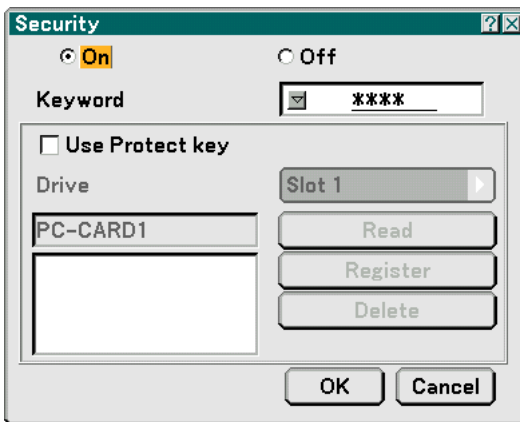

9. Press the SELECT ▼ button to highlight [OK] and press the ENTER button.

The confirmation screen will be displayed.

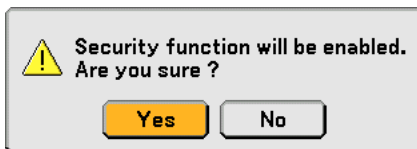

10. Select [Yes] and press the ENTER button.

The Security Function is now enabled.

NOTE: A PC card can be used as a protect key. You can skip the keyword entry by inserting a registered PC card when turning on the projector. (→ page 82)

Checking If Security is enabled

Turn off the projector and turn it back on to check if the Security function is enabled.

1. Press the POWER (ON/STANDBY) button.

The [Power Off / Are you sure?] message will appear.

Press the ENTER button or the POWER (ON/STANDBY) or the POWER OFF button again.

The lamp lights off and the POWER indicator flashes orange. Please wait until the POWER indicator changes from flashing to steady light.

2. When the POWER indicator lights steady orange, push the Main POWER switch to the off position (O).

The projector will turn off.

3. Push the Main POWER switch to the on position (I).

The POWER indicator lights orange. The projector is in standby condition.

4. Press and hold the POWER (ON/STANDBY) button for a minimum of two seconds.

The projector will turn on. The [Projector is locked! Enter your keyword.] message will be displayed at the bottom of the screen.

5. Press the MENU button.

The Keyword entry screen will be displayed

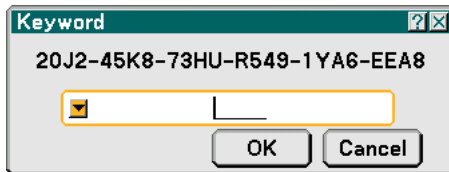

6. Press the ENTER button.

The Software keyboard will be displayed.

7. Use the same procedures as steps 1 to 7 described in the “Assigning a Keyword for the first time” section to enter “1234”.

Each time one number is entered, an “*” (asterisk) will appear. Keyword appears as asterisks so the real keyword is hidden.

8. After entering your keyword, highlight [OK] and press the ENTER button.

The Software keyboard will disappear. This will allow you to operate the projector.

Disabling the Security

1. Press the MENU button.

The on-screen menu will be displayed.

NOTE: Immediately after the projector has been turned on and the "Projector is locked! Enter your keyword." message is displayed at the bottom of the screen, pressing the MENU button will display the Keyword entry will be displayed. At this time, pressing the MENU button will display the on-screen menu.

2. Press the SELECT ► button to highlight [Setup] and press the ENTER button.

The page tab [Basic] will be highlighted.

3. Press the SELECT ► button twice to highlight the page tab [Security].

4. Press the SELECT ▼ button four times to highlight [Security] and press the ENTER button.

The Keyword entry screen will be displayed

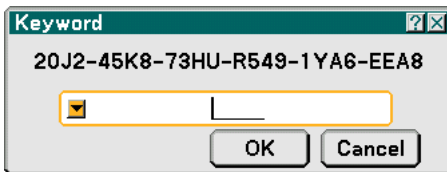

5. Press the ENTER button.

The Software keyboard will be displayed.

6. Use the same procedures as steps 1 to 7 described in the "Assigning a Keyword for the first time" section to enter "1234".

Each time one number is entered, an "*" (asterisk) will appear. Keyword appears as asterisks so the real keyword is hidden.

7. After entering your keyword, highlight [OK] and press the ENTER button.

The Software keyboard will disappear. The Security screen will be displayed.

8. Highlight [On] and press the SELECT ► button to highlight [Off].

9. Press the SELECT ▼ button to highlight [OK] and press the ENTER button.

The Security Function is now disabled.

NOTE: Do not forget your keyword. However, if you forget your keyword, Dukane or your dealer will provide you with your Release Code upon proof of ownership.

11 Using a USB Memory Device

The projector is compatible with a USB memory device which supports the viewer and security features.

- To use a USB memory device, connect the device to the USB port (type A).
- Select one of the drive icons for your USB memory in a pane on the left side of the Viewer window.
- To use a USB memory device as a Protect key for Security function, select one from the Drive icons in the Security setting screen. (→ page 82)

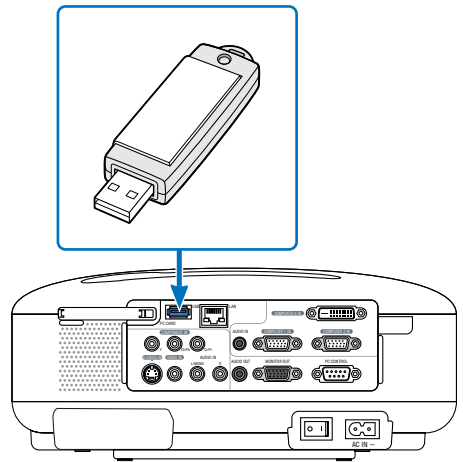

NOTE:

- Use commercially available USB memory devices. Some USB memory devices (brands) may not work.
- The projector does not support NTFS formatted flash memory card or USB memory device. Be sure to use a flash memory card or USB memory device formatted with the FAT32, FAT16 or FAT file system. To format your flash memory card or USB memory device in your computer, refer to the document or help file that comes with your Windows.
- You cannot use a USB memory device when connecting a USB mouse to the projector.
- Do not do the following while the USB memory device's access indicator is lit or flashing (while data is being accessed.) Doing so can damage your USB memory device. Back up your data in case it will need to be restored.
 - * Pulling out the USB memory device from the USB port of the projector.
 - * Turning off the main power switch or unplugging the power cable.
- The drive for "USB 1-4" is displayed only when the USB memory device is connected to the projector.
- Some USB memory devices (brands) cannot be used as Protect key for the projector's Security function.

CAUTION: Do not insert a USB memory device into the LAN port (RJ-45). Doing so can cause damage to the LAN port (RJ-45).

12 Operation Using an HTTP Browser

Overview

The use of HTTP server functions will allow control of the projector from a web browser without the installation of special software. Please be sure to use "Microsoft Internet Explorer 4.x" or a higher version for the web browser. (This device uses "JavaScript" and "Cookies" and the browser should be set to accept these functions. The setting method will vary depending on the version of browser. Please refer to the help files and the other information provided in your software.)

NOTE:

* The display's or button's response can be slowed down or operation may not be accepted depending the settings of your network. Should this happen, consult your network administrator.

* The projector may not respond if its buttons are repeatedly pressed in rapid intervals. Should this happen, wait a moment and repeat. If you still can't get any response, turn off and back on the projector.

Access is gained to the HTTP server functions by specifying

`http:// <the projector's IP address> /index.html`

in the entry column of the URL.

CAUTION:

Do not use the HTTP Server functions and PC Control Utility 3.0 included on the supplied CD-ROM. Using both at the same time may result in a connection failure or slow response.

Preparation Before Use

Make network connections and set up the projector and confirm that it is complete before engaging in browser operations. (→ [LAN Mode] on page 86)

Operation with a browser that uses a proxy server may not be possible depending on the type of proxy server and the setting method. Although the type of proxy server will be a factor, it is possible that items that have actually been set will not be displayed depending on the effectiveness of the cache, and the contents set from the browser may not be reflected in operation. It is recommended that a proxy server not be used unless it is unavoidable.

Handling of the Address for Operation via a Browser

Regarding the actual address that is entered for the address or entered to the URL column when operation of the projector is via a browser, the host name can be used as it is when the host name corresponding to the IP address of the projector has been registered to the domain name server by a network administrator, or the host name corresponding to the IP address of the projector has been set in the "HOSTS" file of the computer being used.

Example 1: When the host name of the projector has been set to "pj.nec.co.jp",
`http://pj.nec.co.jp/index.html`
 is specified for the address or the entry column of the URL.

Example 2: When the IP address of the projector is "192.168.73.1", access is gained to the
 HTTP server functions by specifying
`http://192.168.73.1/index.html`
 for the address or the entry column of the URL.

Structure of the HTTP Server

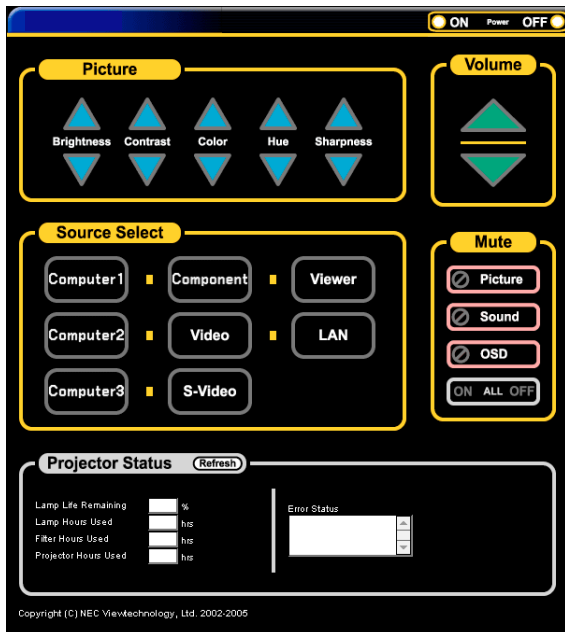

Power: This controls the power of the projector.

- On Power is switched on.
- Off Power is switched off.

Volume: This controls the volume of the projector.

- ▲ Increases the volume adjustment value.
- ▼ Decreases the volume adjustment value.

Mute: This controls the mute function of the projector.

- Picture On Mutes the video.
- Picture Off Cancels the video muting.
- Sound On Mutes the audio.
- Sound Off Cancels the audio muting.
- OSD On Mutes the on-screen display.
- OSD Off Cancels the muting of the on-screen display.
- All On Mutes each of the video, audio, and on-screen display functions.
- All Off Cancels the muting of each of the video, audio, and on-screen display functions.

Picture: Controls the video adjustment of the projector.

- Brightness ▲ ... Increases the brightness adjustment value.
- Brightness ▼ ... Decreases the brightness adjustment value.
- Contrast ▲ Increases the contrast adjustment value.
- Contrast ▼ Decreases the contrast adjustment value.
- Color ▲ Increases the color adjustment value.
- Color ▼ Decreases the color adjustment value.
- Hue ▲ Increases the hue adjustment value.
- Hue ▼ Decreases the hue adjustment value.
- Sharpness ▲ ... Increases the sharpness adjustment value.
- Sharpness ▼ ... Decreases the sharpness adjustment value.

- The functions that can be controlled will vary depending on the signal being input to the projector.

Source Select: This switches the input connector of the projector.

- Computer1 Switches to the COMPUTER 1 IN connector.
- Computer2 Switches to the COMPUTER 2 IN connector.
- Computer3 Switches to the COMPUTER 3 IN connector.
- Component Switches to the COMPONENT IN connectors.
- Video Switches to the VIDEO IN connector.
- S-Video Switches to the S-VIDEO IN connector.
- Viewer Switches to the Viewer.
- LAN Switches to a LAN signal.

Projector Status: This displays the condition of the projector.

- Lamp Life Remaining Displays the remaining life of the lamp as a percentage.
- Lamp Hours Used Displays how many hours the lamp has been used.
- Filter Hours Used Displays how many hours the filter has been used.
- Projector Hours Used . Displays how many hours the projector has been used.
- Error Status Displays the status of errors occurring within the projector.
- Refresh Updates the display of the following conditions.

13 Using the Projector to Operate a Computer Connected on a Network (Desktop Control Utility 1.0)

When Desktop Control Utility 1.0 on the included User Supportware 3 CD-ROM is installed on the computer, that computer can be operated using the projector over a network.

For example, say you have a PowerPoint file on a computer in your office that you want to use for a presentation at a meeting. If the computer in the office is connected by LAN to the projector in the meeting room, the projector can be operated to project the image of the desktop of the computer (Windows 2000 or XP) in the office and display the PowerPoint file during the meeting. This eliminates the need for taking the computer from the office to the meeting room.

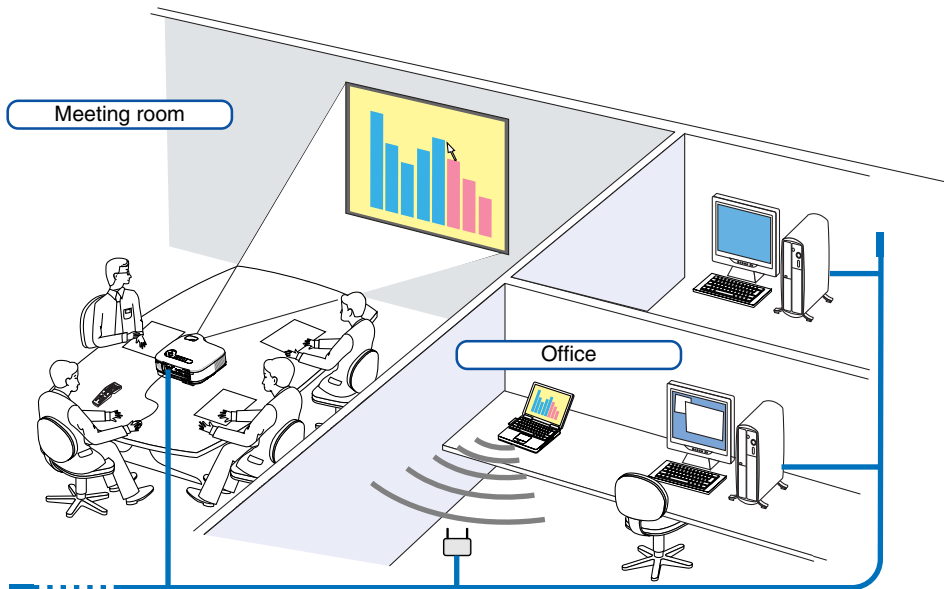

Disclaimer

You can use the Desktop Control Utility 1.0 to operate a computer located in a separate room from the projector over a network. This means there might be potential security risks that you may be exposed to which could cause damage by unauthorized access or illegal use. We recommend you take some measures to prevent third parties from unauthorized access to your data or information.

We share neither liability nor responsibility to any loss or damages arising from information leak or power down without notice.

NOTE: In Windows operating system, click [Control Panel] → [Power Options] → [System Standby] → [Never]. This will disconnect a LAN connection when the computer goes in standby mode.

NOTE: To use the Desktop Control Utility 1.0, you need to have a USB mouse inserted into the USB port of the projector.

Operations on the Computer

1. **Connect the computer to the LAN and make the required settings.**
2. **Install Desktop Control Utility 1.0 on the computer.**
 - For instructions on installation, refer to the included "Software Utility Installation Guide".
 - For instructions on operating the software, see the Desktop Control Utility 1.0's help file.
3. **Prepare the documents to be presented at the meeting and save them on the computer.**
4. **Start up Desktop Control Utility 1.0.**

The Startup password window appears.

Window at the first startup

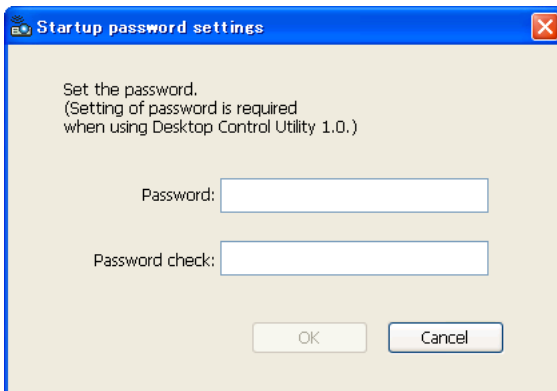

Window after entering your startup password

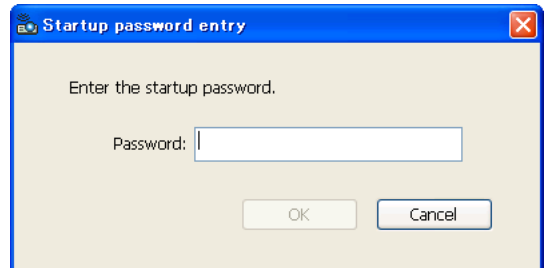

Important:

- Your startup password will be required each time you start Desktop Control Utility 1.0.
- If you forget or lost your startup password, install the program again.

5. **Input the startup password and click [OK].**

The [Current password] input window appears.

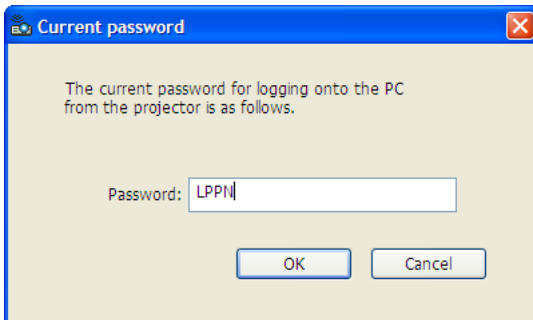

NOTE: The [Current password] will be changed each time you start Desktop Control Utility 1.0.

6. **Make a note of the password.**
7. **Click [OK].**

Desktop Control Utility 1.0 starts.

Go to the room where the projector is installed, taking the password you made a note in the previous Step [6].

Operations on the projector – Connecting to the computer

1. Make the LAN settings on the projector.

Make the LAN settings at [Setup] → [Installation] → [LAN Mode] in the menu. (→ page 86)

2. Connect a commercially available USB mouse to the projector. (→ page 35)
3. Click anywhere on the screen with the USB mouse.

The menu appears.

4. Click [Source], then click [LAN].

The help message is displayed.

The message is displayed only when a password for Desktop Control Utility 1.0 is not assigned.



5. Follow the message to press the MENU button on the projector cabinet or the remote control. The connections bar appears at the bottom left of the screen.



6. Click the password input icon .
7. Click [Entry].



The password input window appears.

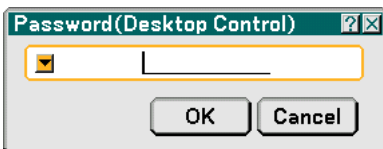

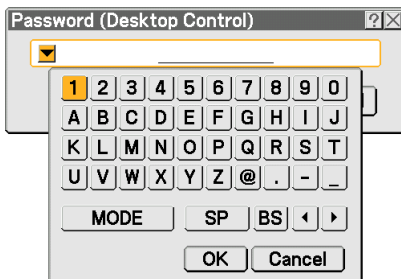

8. Click .

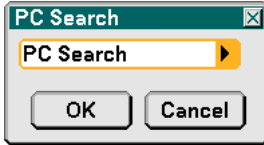

The character input window appears. (→ page 117)

9. *Input the password you made a note of in the previous Step [6] in “Operations on the Computer”.*
10. *Input the password and click [OK].*
The password input window is turned off.
11. *Click the PC search icon .*
The PC search window appears.



12. *Click [OK].*
The connection selection window appears.
 - *To search by inputting the IP address of the connected computer, click  on the PC Search window, click [Input IP Address], then click [OK].*
13. *Click the computer to which you want to connect, then click [OK].*
The desktop of the connected computer appears.





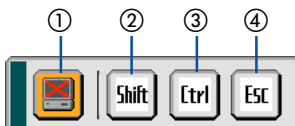

NOTE: Once the desktop appears, the menu will no longer appear when the USB mouse is clicked. To display the menu while the desktop is displayed, press the button on the projector itself or on the remote control.

Operations on the projector –Operating the desktop

A USB mouse connected to the projector can be used to operate the displayed desktop. If the MENU button on the projector cabinet or the remote control is pressed while the desktop is displayed, an additional operations bar appears at the bottom left of the screen.



The following operations are available only with buttons on the projector cabinet or the remote control.

- ①  Disconnect icon Use to cut off communications with the computer.
- ②  Shift icon Select this icon and press the ENTER button to set the shift lock mode. Select this icon and press the ENTER button again to cancel the shift lock mode.
- ③  Ctrl icon Select this icon and press the ENTER button to set the control lock mode. Select this icon and press the ENTER button again to cancel the control lock mode.
- ④  Esc icon Use to do the same operation as when the “Esc” button on the computer is pressed. Use it for example to stop a PowerPoint slideshow.

Operations on the projector – Disconnecting communication

1. Press the MENU button while the desktop is displayed.

The additional operations bar appears at the bottom left of the screen.



2. Select the disconnect icon  and press the ENTER button.

The connections bar appears at the bottom left of the screen.

To reconnect the communication, click the PC search icon  and repeat steps 12 and 13 in the previous page.

NOTE: Disconnection is possible by clicking the projector icon and then “Disconnect” on the task bar.

Operations on the projector – Exiting the desktop operation

Exiting the desktop operation using the taskbar in Windows.

1. Click the projector icon  on the taskbar while the desktop is displayed.

The pop-up menu appears.



2. Click [Exit].

Desktop Control Utility 1.0 quits

3. Click anywhere on the screen.

The connections bar appears at the bottom left of the screen.

4. Click again anywhere on the screen.

The menu appears.

5. Click [Source] and then click any other source than [LAN].

The menu turns off.

5. Using the Viewer

① Making the Most out of the Viewer Function

Features

You can view presentation data and play images on the projector. A PC card is used to view presentation data prepared on the computer and to play images projected with the projector.

The Viewer feature allows you to view slides stored on a PC memory card (referred to as PC card in this manual) or USB memory on the projector. Even if no computer is available, presentations can be conducted simply with the projector. This feature is convenient for holding presentations at meetings and in offices, as well as for playing images taken on digital cameras.

NOTE:

- *To use the Viewer, first you need to create presentation materials on your PC (JPEG, BMP, GIF*1, PNG*1, Index*2 files). For creating presentation materials using the Ulead Photo Explore 8.0, see the supplied "User Supportware 3 User's Guide" or On-line help in Ulead Photo Explorer 8.0.*

**1 Both PNG and GIF format support non-interlaced images only.*

**2 "Index" file is a file created using the Ulead Photo Explore 8.0 contained on the supplied User Supportware 3 CD-ROM. See the supplied "User Supportware 3 User's Guide" for installing the Ulead Photo Explore 8.0 on your computer.*

Easy to use

- Presentations can be started immediately simply by inserting a PC card or USB memory (not supplied)
- Easy slide switching
- Remote control operation
- Jumping to a list of slides or any specific slide

Simple utility software (for computer)

- Ulead Photo Explore 8.0SE Basic operable on Windows XP/Windows 2000.
 - Slides can be created by capturing the currently displayed image.
 - Control screen for displaying lists of slides and editing.
- * Microsoft, Windows and PowerPoint are registered trademarks of Microsoft Corporation.

② Operating the Viewer Function from the Projector (playback)

This section describes the operation for showing slides created using the Viewer function with the projector. It is also possible to make slides directly from the images projected with the projector.

Projecting slides (Viewer)

Preparation: Store JPEG or BMP files (JPEG, BMP, non-interlaced GIF or non-interlaced PNG files) in a PC card or USB memory inserted into your PC.

1. **Insert a PC card into the PC card slot or USB memory into the USB port of the projector.**
2. **Press the VIEWER button on the remote control or select the [Viewer] from the source list.**
An image stored in the PC card or USB memory will be displayed.
3. **Press the MENU button to display the Viewer menu.**

The Viewer menu will appear when you press the MENU button on the remote control or the projector cabinet.

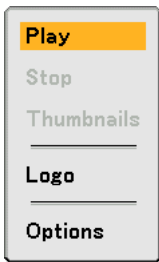

The Viewer menu includes the following commands:

- Play Plays back automatically or manually depending on the setting in Options. This allows you to move on to the next slide when [Manual] is selected in the [Play Mode].
- Stop This allows you to stop Auto Play while you are playing back and to resume playing from the selected slide or folder when [Auto] is selected in the [Play Mode].
- Thumbnails Displays a list of thumbnails of Graphic files stored in the PC card or USB memory inserted into the projector.
- Logo Replace the default background logo with another logo in JPEG, BMP, non-interlaced GIF or non-interlaced PNG format.
- Options Displays the Viewer setting options.

4. **Select [Play] and then press the ENTER button to display the first slide or to start playing slides automatically.**

Viewer Window Elements

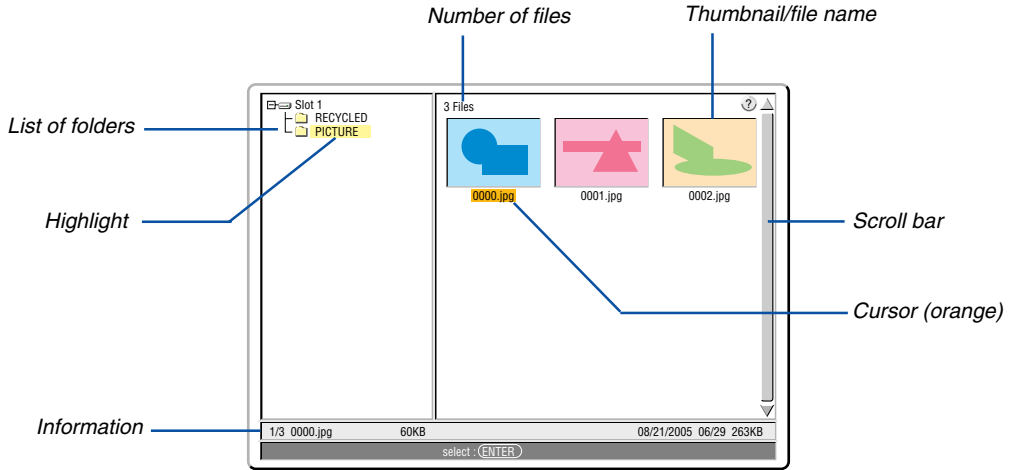

- Highlight Indicates the selected folder or drive.
- List of folders Indicates folders contained on a PC card or USB memory.
- Information Indicates information of the selected file or folder.
 Folder: folder name, creation date (month/day/year), creation time (hour/minute).
 File: slide number/number of displayable slides in a folder, file name, creation date (month/day/year), creation time (hour/minute), file size.
- Number of files Indicates number of displayable slides in the selected folder. The maximum number of images recognized as slides within one directory is about 1000.
- Thumbnail/file name Indicates thumbnails and names contained in a folder.
- Cursor Indicates the selected slide.
- Scroll bar Used to view folders or files not visible in the window.

Setting Option for Viewer

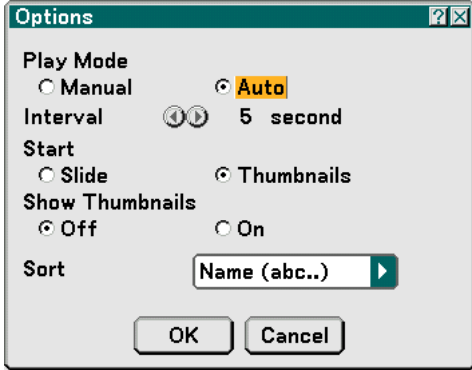

Play Mode:

- Manual Views a slide manually when the Viewer source is selected.
- Auto Plays back slides automatically when the Viewer source is selected.

Interval:

Specifies interval time between 5 and 300 seconds.

Start:

Specifies start screen when the Viewer source is selected.

Show Thumbnails:

Selecting the Viewer source will display a list of thumbnails of graphic files stored in the PC card or USB memory when [On] is selected.

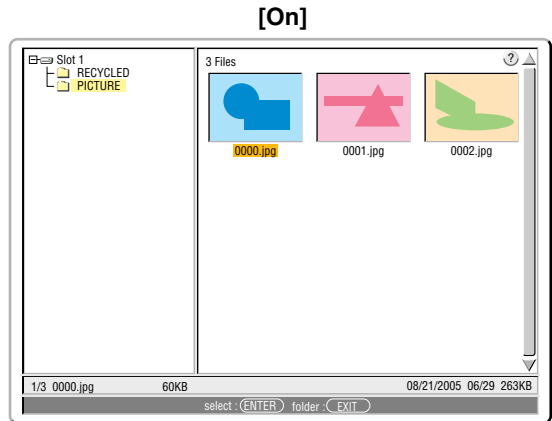
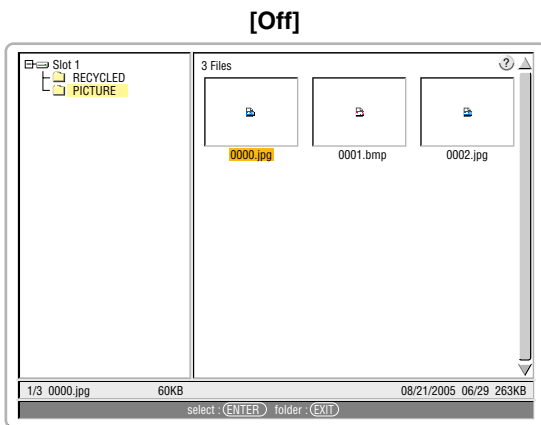

Sort:

Rearranges the slides or thumbnails by name, extension, date or size.

NOTE: This setting is not available for the following folders:

** Folders created with the "Output Viewer" feature of Ulead Photo Explorer 8.0 or with Viewer PPT Converter 3.0*

OK/Cancel:

- To close the Options menu with saving changes, select [OK] and press the ENTER button.
- To close the Options menu without saving changes, select [Cancel] and press the ENTER button.

Exiting Viewer

To exit Viewer, switch to another input such as Computer 1, Computer 2, Computer 3 (LT380 only), Component, Video, S-Video or LAN.

- * To switch to another input, there are two ways:
- * Press the COMPUTER 1, COMPUTER 2, COMPUTER 3, COMPONENT, VIDEO, S-VIDEO or LAN button on the remote control.
- * Press the MENU button on the remote control to display the Viewer menu. Press the MENU button again to display the main menu and select the input from the [Source] submenu.

With this function it is possible to switch directly to a slide when the picture of a VCR or computer is being projected. Example: When conducting presentations using a combination of slides and moving pictures from a VCR, etc., it is possible to switch from a Viewer slide to the video picture then back to the Viewer slide simply by using the Viewer button.

NOTE: Even if you switch the current Viewer source to another source, the current slide is retained. When you return back to the Viewer, you will get the slide that has been retained.

Viewing Digital Images

Digital images can be played with the Viewer if the following conditions are met:

- If the image can be stored on an MS-DOS format PC card.
- If the image can be stored in a format supported by the Viewer. With the Viewer, images on the card are searched for in directories and images in JPEG, BMP, non-interlaced GIF or non-interlaced PNG format are recognized as slides.

NOTE: The maximum number of images recognized as slides within one directory is about 1000.

③ Changing Background Logo

You can change the default background logo using the Viewer feature.

NOTE: File size must be 256KB or less. File formats other than JPEG, BMP, non-interlaced GIF or non-interlaced PNG are not available.

Preparation: Store JPEG or BMP files (JPEG, BMP, non-interlaced GIF or non-interlaced PNG files) in a PC card or USB memory inserted into your PC and insert the PC card into the projector's slot or USB memory into the projector's USB port.

1. Press the **VIEWER** button on the remote control to display an image.
2. Press the **MENU** button to display the Viewer menu.



3. Use the **▼** button to select [Thumbnails] and then press the **ENTER** button.
The Thumbnail screen will be displayed.

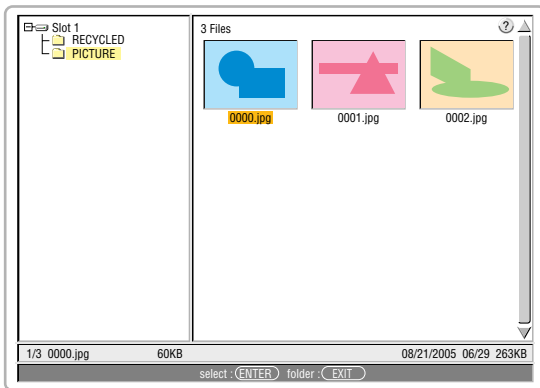

*NOTE: To change highlight from the Thumbnails screen (right window) to a directory tree (left window), press the **EXIT** button. To return highlight to the Thumbnails screen, press the **ENTER** button.*

4. Use **▲▼◀▶** button to select a file (slide) for your background logo.
5. Press the **MENU** button to display the Viewer menu.
6. Use the **▼** button to select [Logo] and then press the **ENTER** button.

A confirmation dialog box will be displayed.



7. Use the **◀** button to select [Yes] and press the **ENTER** button. This completes changing a logo for the background.

* Once you have changed the background from the logo to another, you cannot return the logo to background even by using [Reset]. To put the logo back in the background logo, repeat the above steps.

6. Using On-Screen Menu

① Using the Menus

1. Press the **MENU** button on the remote control or the projector cabinet to display the menu.

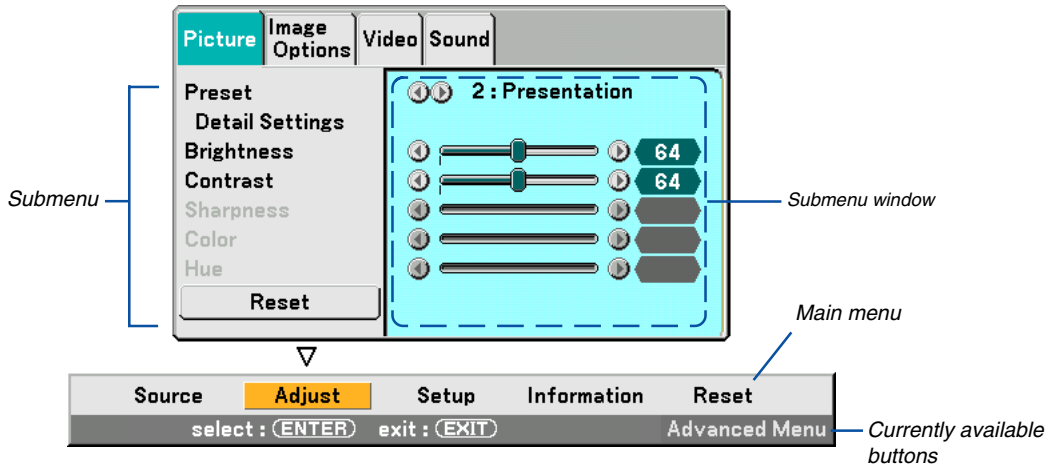

NOTE: The commands such as ◀▶, ENTER, EXIT in the gray bar show available buttons for your operation.

2. Press the **SELECT** ◀▶ buttons on the remote control or the projector cabinet to display the submenu.
3. Press the **ENTER** button on the remote control or the projector cabinet to highlight the top item or the first tab.
4. Use the **SELECT** ▲▼ buttons on the remote control or the projector cabinet to select the item you want to adjust or set.
You can use the **SELECT** ◀▶ buttons on the remote control or the projector cabinet to select the tab you want.

NOTE: You can select a tab only when the tab color is orange.

5. Press the **ENTER** button on the remote control or the projector cabinet to display the submenu window.
6. Adjust the level or turn the selected item on or off by using the **SELECT** ▲▼◀▶ buttons on the remote control or the projector cabinet.
Changes are stored until you adjust it again.
7. Repeat steps 2 -6 to adjust an additional item, or press the **EXIT** button on the remote control or the projector cabinet to quit the menu display.

NOTE: When a menu or message is displayed, several lines of information may be lost, depending on the signal or settings.

2 Menu tree

Basic menu items are indicated by shaded area.

Menu	Item				
Source		Computer 1, Computer 2, Computer 3 (LT380 only), Component, Video, S-Video, Viewer, LAN, Entry List			
Adjust	Picture	Preset	1 to 6		
			Detail Settings	Reference	High-Bright, Presentation, Video, Movie, Graphic, sRGB
			Gamma Correction	Dynamic, Natural, Black Detail	
			Color Temperature	5000, 6500, 7800, 8500, 9300, 10500	
			White Balance	Brightness RGB, Contrast RGB	
			Color Correction	Red, Green, Blue, Yellow, Magenta, Cyan	
		Brightness			
		Contrast	Manual, Auto		
		Sharpness			
		Color			
		Hue			
		Reset			
Image Options	Image Options	Clock			
		Phase			
		Horizontal Position			
		Vertical Position			
		Blanking	Top, Bottom, Left, Right		
		Overscan	0%, 5%, 10%		
		Aspect Ratio	4:3	4:3, Letterbox, Wide Screen, Crop	
			16:9	4:3 Window, Letterbox, Wide Screen, 4:3 Fill	
		Video	Video	3D Y/C Separation	Off, On: Still, Normal, Movie
				Vertical Enhancer	Off, 1, 2, 3
Deinterlace	Off, On: Still, Normal, Movie				
Telecine	Off, On: 2-2/2-3 Auto, 2-2 On, 2-3 On				
Sound		Volume, Bass, Treble, Balance, 3D Surround			
Setup	Basic	Keystone	Auto, Manual		
		Cornerstone			
		Wall Color	Off, Blackboard, Blackboard (Gray), Light yellow, Light green, Light blue, Sky blue, Light rose, Pink		
		Lamp mode	Normal, Eco		
		Menu Mode	Basic Menu, Advanced Menu		
		Language	English, Deutsch, Français, Italiano, Español, Svenska, Suomi, Norsk, Nederlands, Türkçe, Polski, Русский, Ελληνικά, Magyar, Português, Čeština, العربية, Dansk, 日本語, 한국어, 中文		
	Menu	Menu	Color Select	Color1 to 5, Monochrome	
			Display Select	Source: On, Off / Message: On, Off	
			Display Time	Manual, Auto 5 sec, Auto 15 sec, Auto 45 sec	
			Background	Blue, Black, Logo	
Security	Security	Control Panel Lock	Off, On		
		Menu Lock	Off, On		
		Logo Lock	Off, On		
		Security	Off, On, Keyword, Use Protect Key, Drive, Read, Register, Delete		

6. Using On-Screen Menu

Menu	Item			
Setup	Installation	Orientation	Desktop Front, Ceiling Rear, Desktop Rear, Ceiling Front	
		Screen	Screen Type: 4:3, 16:9 / Position	
		LAN Mode	Built-in	
			PC Card	Advanced: Network Type, WEP
			Domain	
			Mail	
		Projector Name		
		Communication Speed	4800, 9600, 19200, 38400	
		Standby Mode	Normal, Power-Saving	
		Options	Auto Adjust	Off, Normal, Fine
			Auto Start	Off, On
	Power Management		Off, 0:05, 0:10, 0:20, 0:30	
	Fan Mode		Auto, High	
	Default Source Select		Last, Auto, Select (Computer1, Computer2, Computer3 (LT380 only), Component, Video, S-Video, Viewer, LAN)	
	Signal Select		Computer1	RGB/Component, RGB, Componet, Scart
			Computer2	RGB/Component, RGB, Componet
			Component	Component, Video
	Color System		Component (Video), Video, S-Video	
	S-Video Mode Select		Off, S2	
	OUT Terminal	Last, Computer1, Computer2, Component		
	Tools	ChalkBoard		
		Off Timer	Off, 0:30, 1:00, 2:00, 4:00, 8:00, 12:00, 16:00	
		Mouse	Mouse Pointer: Pointer 1 to 9 / Button: Right Hand, Left Hand Sensitivity: Fast, Medium, Slow	
Information	Usage Time	Lamp Life Remaining, Lamp Hours Used, Filter Hours Used, Projector Hours Used		
	Source Page1	Input Terminal, Signal Type, Video Type, Source Name, Entry No.		
	Source Page2	Horizontal Frequency, Vertical Frequency, Sync Type, Sync Polarity, Scan Type		
	LAN Built-in	IP Address, Subnet Mask, Gateway, MAC Address		
	LAN PC Card	IP Address, Subnet Mask, Gateway, MAC Address		
	LAN Wireless	SSID, Mode, WEP, Channel, Signal Level		
	Version	Firmware, Data		
Reset	Current Signal, All Data, All Data (Including Entry List), Clear Lamp Hours, Clear Filter Hours			

3 Menu Elements

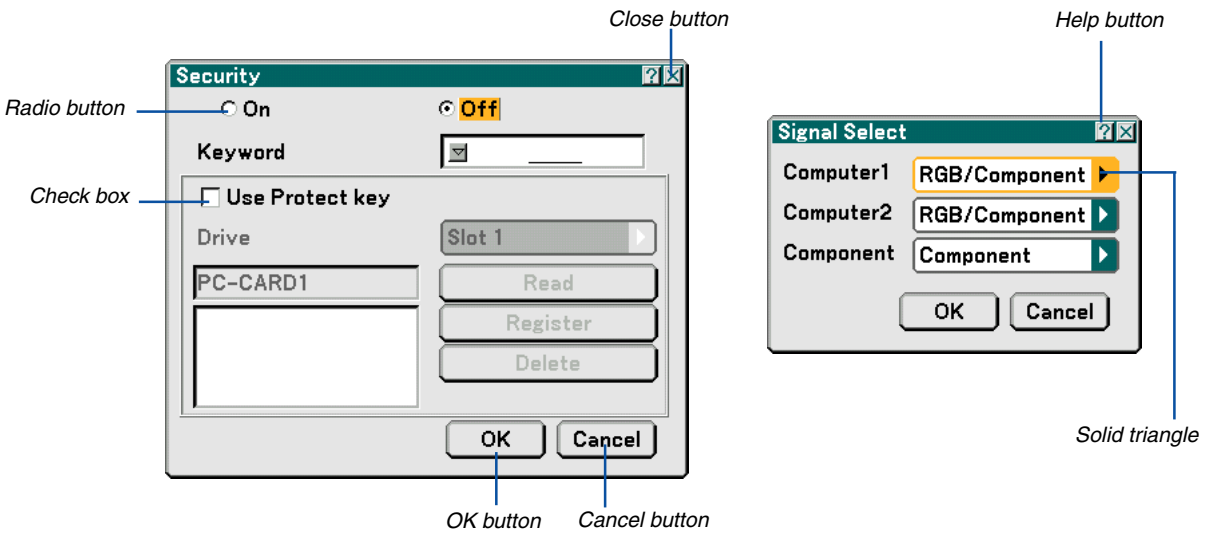
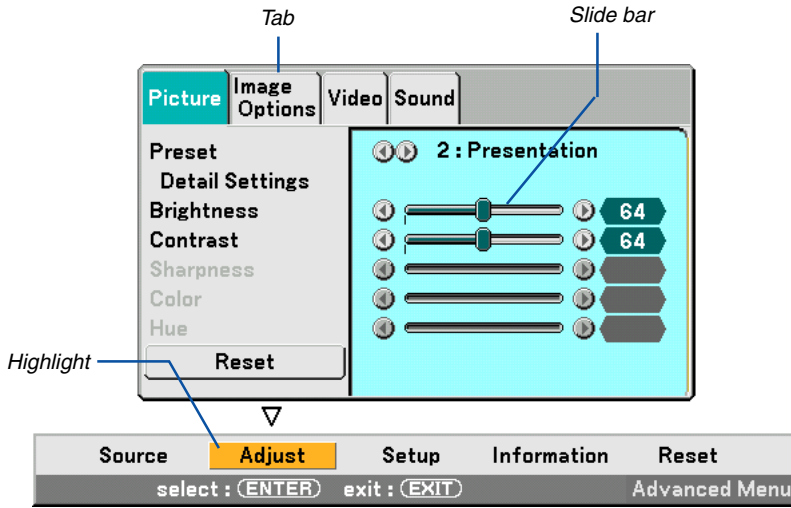

Menu windows or dialog boxes typically have the following elements:

- Highlight..... Indicates the selected menu or item.
- Solid triangle Indicates further choices are available. A highlighted triangle indicates the item is active.
- Tab Indicates a group of features in a dialog box. Selecting on any tab brings its page to the front.
- Radio button Use this round button to select an option in a dialog box.
- Check box Place a checkmark in the square box to turn the option On.
- Slide bar Indicates settings or the direction of adjustment.
- OK button Press to confirm your setting. You will return to the previous menu.
- Cancel button Press to cancel your setting. You will return to the previous menu.
- Close button Click to close the window and saving changes. (USB mouse only)
- Help button Indicates that help about that feature is available (USB mouse only). Press the HELP button on the remote control to display help.

4 Menu Descriptions & Functions [Source]

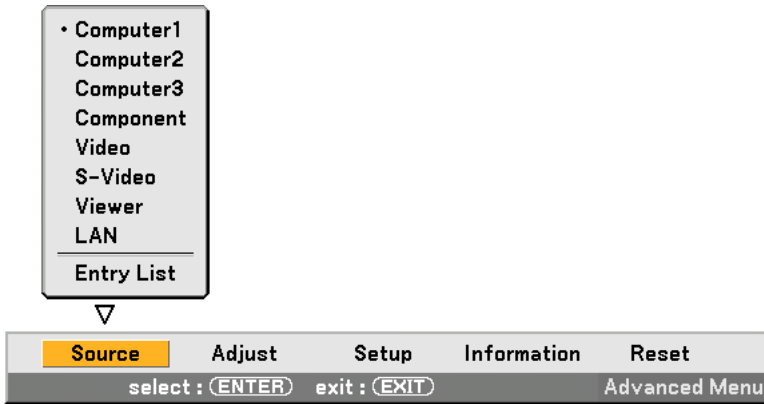

Computer 1 and 2

Selects the computer connected to your COMPUTER 1 or COMPUTER 2 input connector signal.

NOTE: An optional component cable (Component V or ADP-CV1 cable) is needed for a component signal.

Computer 3 (8775 only)

Selects the computer connected to your COMPUTER 3 (DVI-D) connector.

Component

Selects what is connected to your COMPONENT IN (Y, Cb/Pb, Cr/Pr).

Video

Selects what is connected to your VIDEO input-VCR, laser disc player, DVD player or document camera.

S-Video

Selects what is connected to your S-VIDEO input-VCR, DVD player, or laser disc player.

NOTE: A frame may freeze for a brief period of time when a video is played back in fast-forward or fast-rewind with a Video or S-Video source.

Viewer

This feature enables you to make presentations using a PC card that contains captured images and slides created with the exclusive Photo Explore 8.0 contained on the CD-ROM. See the supplied Software Utility Installation Guide for installing the Photo Explore 8.0.

See page 56 for viewing slides.

LAN

Selects a signal from the LAN port (RJ-45) or the optional wireless LAN card plugged into the projector's card slot.

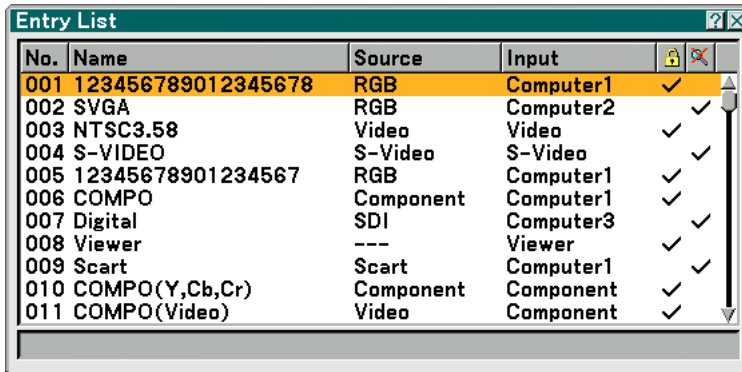
[Entry List]

No.	Name	Source	Input	
001	123456789012345678	RGB	Computer1	✓
002	SVGA	RGB	Computer2	✓
003	NTSC3.58	Video	Video	✓
004	S-VIDEO	S-Video	S-Video	✓
005	12345678901234567	RGB	Computer1	✓
006	COMPO	Component	Computer1	✓
007	Digital	SDI	Computer3	✓
008	Viewer	---	Viewer	✓
009	Scart	Scart	Computer1	✓
010	COMPO(Y,Cb,Cr)	Component	Component	✓
011	COMPO(Video)	Video	Component	✓

Use the SELECT ▲▼ buttons on your remote control or the projector cabinet to select the signal and press the ENTER button on the remote control or the projector cabinet to display the [Entry Edit Command] screen.

Entering the Currently Projected Signal into the Entry List

1. *Display the Entry List.*
2. *Use the SELECT ▲ or ▼ button on your remote control or the projector cabinet to select any number and press the ENTER button on the remote control or the projector cabinet to display the [Entry Edit Command] screen.*
3. *Use the SELECT ◀ or ▶ button to select [Store] and press the ENTER button.*

Using the [Entry List]

Making any adjustments to the current picture will automatically register its adjustments to the [Entry List]. The registered signal can be loaded any time from the [Entry List].

NOTE: Up to 100 presets can be registered except settings on the Picture.

[Entry Edit Command]



You can edit signals on the [Entry List].

- Load Enables you to select a signal from the list.
- Store Enables you to store the currently projected signal.
- Cut Enables you to remove a selected signal from the list and place it on the "clipboard" in the projector.
- Copy Enables you to copy a selected signal from the list and place it on the "clipboard" in the projector.
- Paste Enables you to paste the signal placed on the "clipboard" to any other line of the list.
- Edit Enables you to change source names.

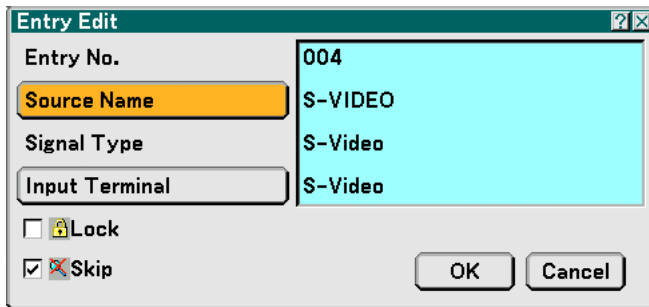

Source Name:

Enter a signal name. Up to 18 alphanumeric characters can be used.

Input Terminal:

Change the input terminal.

Lock:

Set so that the selected signal cannot be deleted when "All Delete" is executed. After executing [Lock], the changes cannot be saved.

Skip:

Set so that the selected signal will be skipped during auto search.

When complete, select OK and press ENTER. To exit without storing the setting, select Cancel. Select [Source Name] and press ENTER to display the Source Name Edit window. You can change source name on this window. Press ▼ to display the software keyboard, which you can enter alphanumeric characters. See page 117 for the key function of the software keyboard.

All Delete This feature enables you to delete all the registered signals in the Entry List.

The following buttons are not available for the currently projecting signals:

- 1) The Cut and Paste buttons on the [Entry Edit Command] screen
- 2) The Input Terminal button on the [Entry Edit] screen

NOTE: When all the signals in the [Entry List] are deleted, the currently projected signal will be also deleted except locked signals.

5 Menu Descriptions & Functions [Adjust]

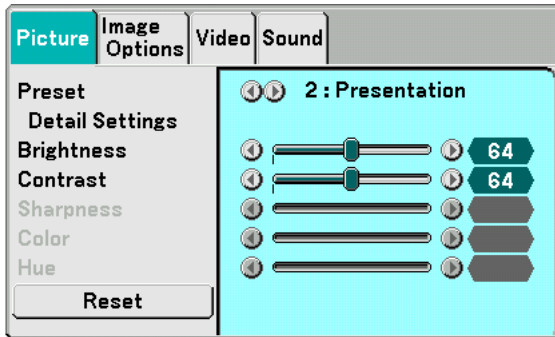

[Picture]

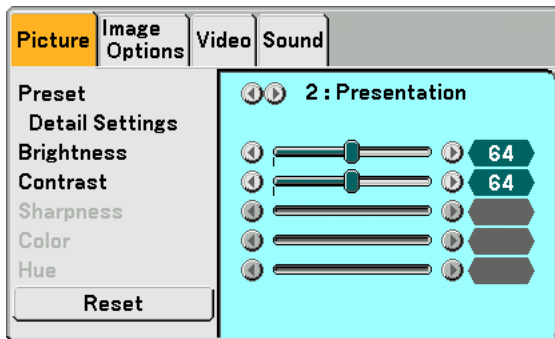

[Preset]

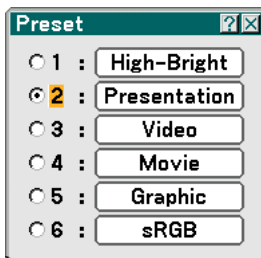

This option allows you to adjust neutral tint for yellow, cyan or magenta. There are six factory presets optimized for various types of images, you can set user adjustable settings.

[Detail Settings]

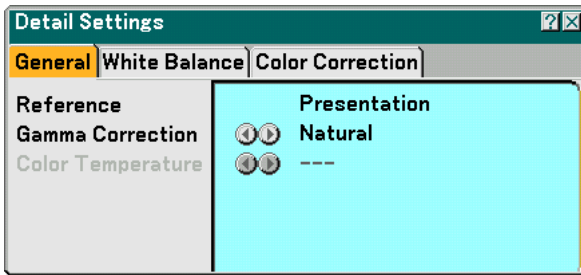

This will provide you with three pages of menus that provide more detailed settings.

[General]

Selecting Reference Setting [Reference]

This feature allows you to use color correction or gamma values as reference data to optimize for various types of images. You can select one of the following six settings.

- High-Bright Recommended for the use in a brightly lit room.
- Presentation Recommended for making a presentation using a PowerPoint file.
- Video Recommended for regular picture such as TV program.
- Movie Recommended for movies.
- Graphic Recommended for graphics.
- sRGB Standard color values.

Selecting Gamma Correction Mode [Gamma Correction]

Each mode is recommended for:

- Dynamic Creates a high-contrast picture.
- Natural Natural reproduction of the picture.
- Black Detail Emphasizes detail in dark areas of the picture.

Adjusting Color Temperature [Color Temperature]

This feature adjusts the color temperature using the slide bar.

Move the slide bar to the right to increase color temperature (more blue); to the left to decrease color temperature (more red).

NOTE:

- When [Presentation] or [High-Bright] is selected in [Reference], this function is not available.
- When [White Balance] settings has been changed, the color temperature value on screen does not reflect the real color temperature.

[White Balance]

Adjusting White Balance [White Balance]

This allows you to adjust the white balance. Brightness for each color (RGB) is used to adjust the black level of the screen; Contrast for each color (RGB) to adjust the white level of the screen.

[Color Correction]

Selecting Color Correction [Color Correction]

Adjusts red, green, blue, yellow, magenta and cyan each independently to correct the tint of the whole screen.

[Brightness]

Adjusts the brightness level or the back raster intensity.

[Contrast]

Adjusts the intensity of the image according to the incoming signal.
You have two options: Manual and Auto.

NOTE: The Auto Contrast function will not work when the on-screen menu or a message is displayed

[Sharpness]

Controls the detail of the image for Video (not valid for RGB and digital signals).

[Color]

Increases or decreases the color saturation level (not valid for RGB and digital signals).

[Hue]

Varies the color level from +/- green to +/-blue. The red level is used as reference. This adjustment is only valid for Video, Component and TV standard inputs (not valid for RGB and digital signals).

[Reset]

The settings and adjustments for [Picture] will be returned to the factory settings with the exception of the following; Preset numbers and [Reference] within the [Preset] screen.

The settings and adjustments under [Detail Settings] within the [Preset] screen that are not currently selected will not be reset.

[Image Options]

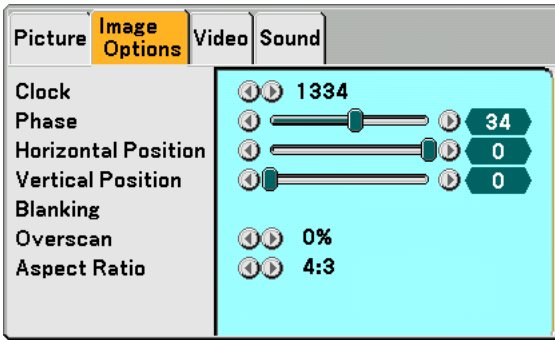

Adjusting Clock and Phase [Clock/Phase]

This allows you to manually adjust Clock and Phase.

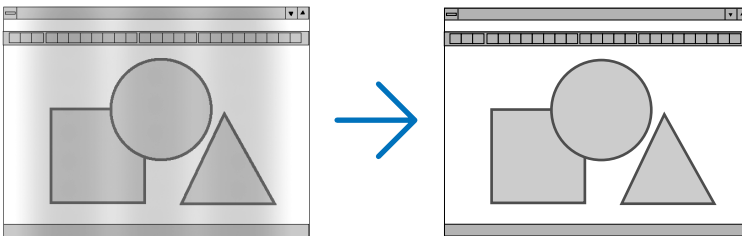

Clock Use this item to fine tune the computer image or to remove any vertical banding that might appear. This function adjusts the clock frequencies that eliminate the horizontal banding in the image. This adjustment may be necessary when you connect your computer for the first time.

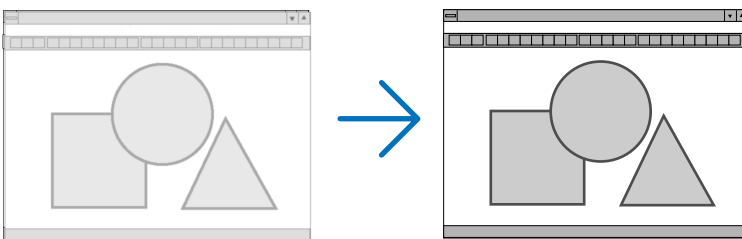

Phase Use this item to adjust the clock phase or to reduce video noise, dot interference or cross talk. (This is evident when part of your image appears to be shimmering.) Use [Phase] only after the [Clock] is complete.

Adjusting Horizontal/Vertical Position [Horizontal/Vertical Position]

Adjusts the image location horizontally and vertically.

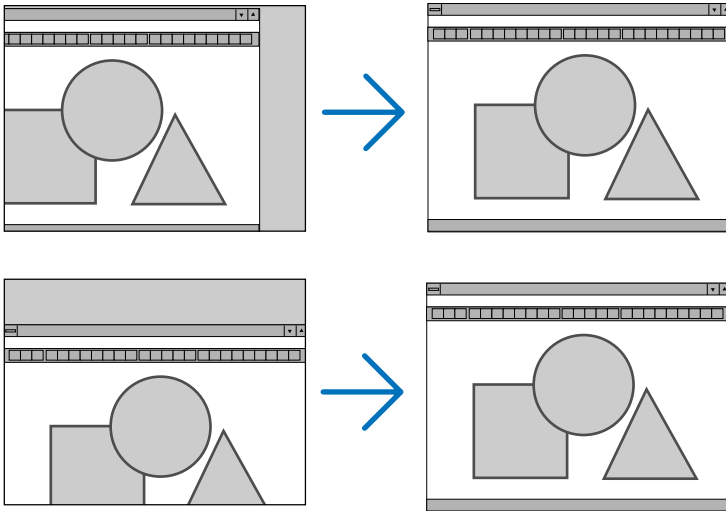

Masking Unwanted Area [Blanking]

This feature allows you to mask any unwanted area of the screen image.

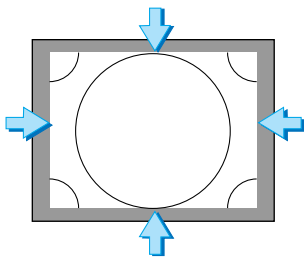

Selecting Overscan Percentage [Overscan]

Select overscan percentage (0%, 5% and 10%) for signal.

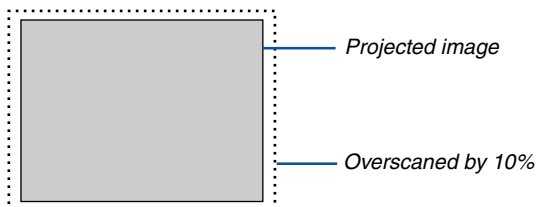

Selecting Aspect Ratio [Aspect Ratio]

Screen Type 4:3

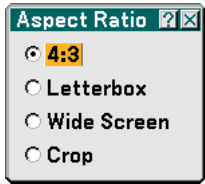

Screen Type 16:9

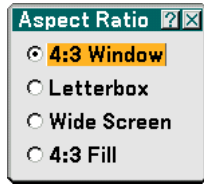

Aspect Ratio allows you to select the best Aspect mode to display your source image. When screen type 4:3 is selected for the source, the following selections will display:

- 4:3 Standard 4:3 aspect
- Letter Box Reduced to display the true aspect with black borders on top and bottom
- Wide Screen Left & Right stretched with black borders on top and bottom
- Crop Left & Right stretched. Left & Right sides cut. Available for 4:3 only.

When screen type 16:9 is selected for the source, the following selections will display:

- 4:3 Window Reduced to display the true aspect with black borders on right and left
- Letter Box Standard 16:9 aspect
- Wide Screen Left and right stretched to display the true aspect
- 4:3 Fill Stretched to display in 16:9 aspect ratio

NOTE: You can adjust image position vertically for a source with black borders on top and bottom. (→ page 85)

NOTE: Please note that using this projector for the purpose of commercial gain or the attraction of public attention in a venue such as a coffee shop or hotel and employing compression or expansion of the screen image with a [Aspect Ratio] or [Screen] setting may raise concern about the infringement of copyrights which are protected by copyright law.

NOTE: During 3D Reform adjustment, [Aspect Ratio] may not be available. Should this happen, first reset the 3D Reform data and then do setting again. Second repeat the 3D Reform adjustment. Changing the aspect ratio can limit 3D Reform in its adjustable range.

Input Signal / Screen Type	4:3	Letterbox	Squeeze
4:3 Screen	4:3	Letterbox	Wide Screen Crop
16:9 Screen	4:3 Window 4:3 Fill	Letterbox	Wide Screen

[Video]

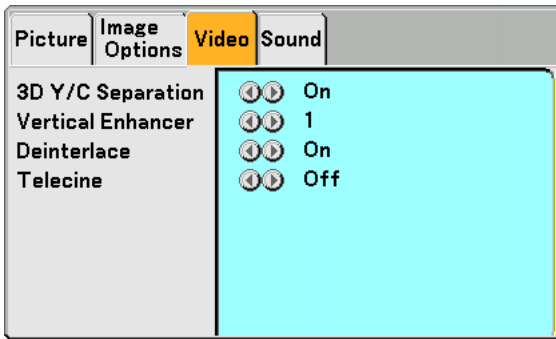

Turning On/Off 3 Dimension Separation [3D Y/C Separation]

This function turns on or off the 3 dimensional separation feature.

- Off Turns off the function.
- On Still Recommended for a still image.
- Normal The projector detects and corrects the image automatically.
- Movie Recommended for a moving image.

TIP: When the image is poor quality, turn on [3D Y/C Separate]. If there is still poor quality, try turning off [Deinterlace] or try turning off [3D Y/C Separate] and select [Normal] in [Deinterlace].

NOTE: This feature is available for NTSC3.58 of Video signal only.

Setting Vertical Edges [Vertical Enhancer]

This function enhances the vertical edges around objects in the image.

NOTE: This function is not available for an RGB, HDTV and Component signal.

Selecting Interlace or Deinterlace [Deinterlace]

This function allows you to select between "Interlace" and "Deinterlace".

- Off Project the interlaced signal.
- On Still Select when a still image is displayed. When this option is selected for a moving image, jitter or artifacts can be seen.
- Normal The projector automatically determines a still or moving image to display a clear picture. If selecting [Normal] causes excess jitter or artifacts, select [Movie].
- Movie Select when a moving image is displayed. This will eliminate jitter and artifacts in a moving image. This option is available only for SDTV.

Setting Telecine Mode [Telecine]

Use 3:2 pull down correction to eliminate jitter and artifacts in video.

NOTE: This feature is available only when [Deinterlace] is turned on and an SDTV signal is selected.

- Off Turns off the Telecine mode.
- On 2-2/2-3 Auto Detects pull-down correction method.
- 2-2 On Uses 2-2 pull-down correction method
- 2-3 On Uses 2-3 pull-down correction method

[Sound]

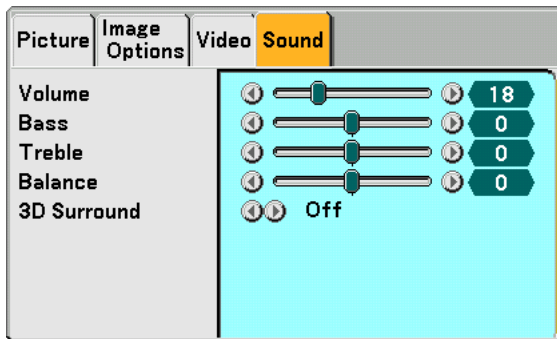

Controlling Sound [Volume/Bass/Treble/Balance]

Adjusts the volume, bass and treble level, left and right balance of the projector speaker and AUDIO OUT (Stereo Mini Jack).

Enabling 3D Surround [3D Surround]

Turn on or off the 3D surround effect.

If the AUDIO OUT stereo mini jack of the projector is connected to an external equipment, adjusting the sound on the external equipment can cause sound to be distorted or cracked, depending on the bass, treble or 3D Surround adjustment. If this happens, return the adjustments of the projector to the factory default (Bass:0, Treble: 0, 3D Surround: 0).

6 Menu Descriptions & Functions [Setup]

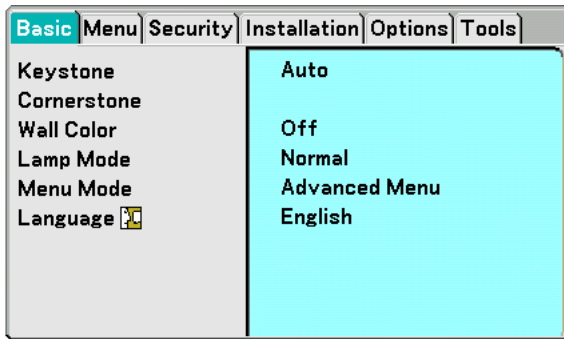

[Basic]

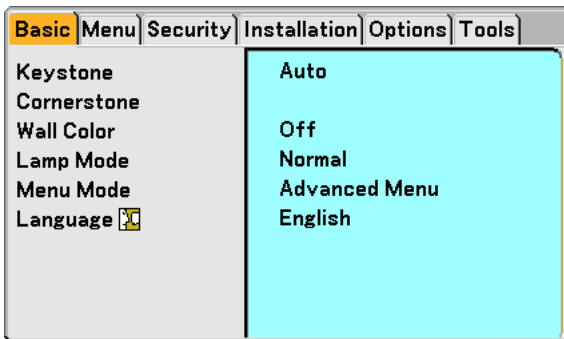

Selecting Keystone Mode [Keystone]

This feature allows you to correct keystone distortion manually or automatically. Selecting this item will display the Keystone setting menu.

- Auto This feature allows the projector to detect its tilt and correct vertical distortion automatically.
- Manual You can correct vertical distortion manually from the menu.
Changes will be saved even when you turn off the projector.
- Adjust You can display the Keystone screen. (→ page 29)

NOTE: When [Cornerstone] is selected, [Adjust] is not available.

Selecting Cornerstone Mode [Cornerstone]

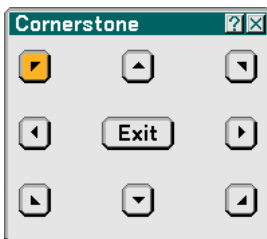

This option allows you to correct trapezoidal distortion. Selecting this item will display the Cornerstone adjustment screen. (→ page 38)

NOTE: When [Keystone] is selected, [Cornerstone] is not available.

Using the Wall Color Correction [Wall Color]

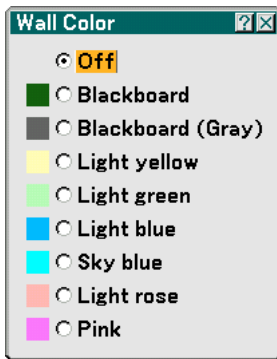

This function allows for quick adaptive color correction in applications where the screen material is not white. The following nine options are available.

Setting Lamp Mode to Normal or Eco [Lamp Mode]

This feature enables you to select two brightness modes of the lamp: Normal and Eco modes. The lamp life can be extended by using the Eco mode. Selecting Eco mode decreases fan noise compared to in Normal mode.

Normal Mode This is the default setting (100% Brightness).

Eco Mode Select this mode to increase the lamp life (80% Brightness).

NOTE: If the projector is overheated in Normal mode, there may be a case where the Lamp mode will be forced into the Eco mode to protect the projector. This mode is called "forced Eco mode".

During "forced Eco mode" cannot be changed from the menu. When the projector is in forced Eco mode, the picture brightness decreases.

When the projector comes back to normal temperature, the Lamp mode returns to Normal mode.

The LAMP indicator's steady green light indicates the lamp is in Eco mode.

Selecting Menu Mode [Menu Mode]

This feature allows you to select two menu modes: Basic Menu and Advanced Menu.

Basic Menu This is the basic menu that contains minimum essentials of menus and commands.

Advanced Menu This is the menu that contains all the available menus and commands.

Selecting Menu Language [Language]

You can choose one of 21 languages for on-screen instructions.

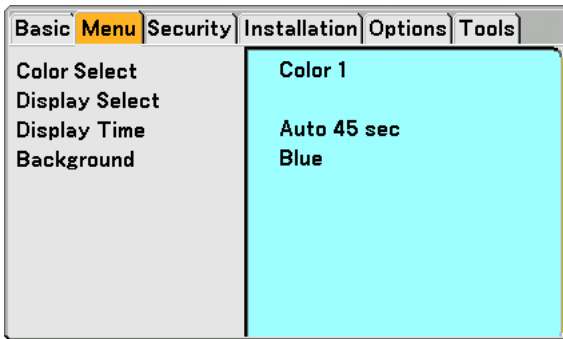
[Menu]**Selecting Menu Color [Color Select]**

You can choose a color for the menu.

Turning On / Off Source Display and Message [Display Select]

Source This option turns on or off input name display such as Computer 1, Computer 2, Computer 3 (LT380 only), Component, Video, and No Input to be displayed in the top right corner of the screen.

Message This option turns on and off messages. Even though selecting [Off], the following message will appear.

* "The lamp has reached the end of its usable life. Please replace the lamp." Press the EXIT button and the message will disappear.

* "Projector is locked" When unlocking the projector security, the message will disappear.

Selecting Menu Display Time [Display Time]

This option allows you to select how long the projector waits after the last touch of a button to turn off the menu. The preset choices are [Manual], [Auto 5 sec], [Auto 15 sec], and [Auto 45 sec]. The [Auto 45 sec] is the factory preset.

Selecting a Color or Logo for Background [Background]

Use this feature to display a blue/black screen or logo when no signal is available. The default background is blue. You can change the logo screen using the Viewer feature. (→ pages 61)

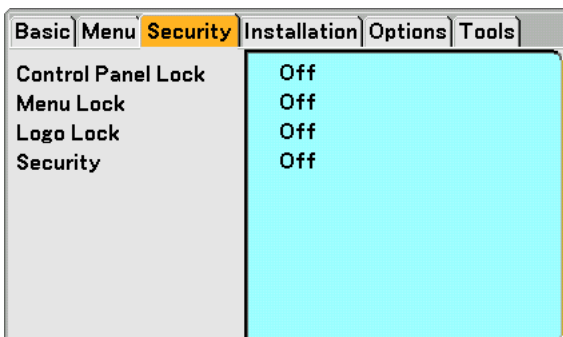
[Security]**Disabling the Cabinet Buttons [Control Panel Lock]**

This option turns on or off the Control Panel Lock function.

NOTE:

- This Control Panel Lock does not affect the remote control functions.
- When the control panel is locked, pressing and holding the EXIT button on the projector cabinet for about 10 seconds will change the setting to [Off].

Setting a Password [Menu Lock] / [Logo Lock]

A password can be set for your projector to avoid operation by an unauthorized person.

When [Menu Lock] is set, changing the menu from Basic to Advanced will display the Password input screen.

When [Logo Lock] is set, doing any one of the following two operations will display the Password input screen.

- Changing the background either from or to [Logo]
- Changing the logo data in a PC card or USB memory.

[Entry]

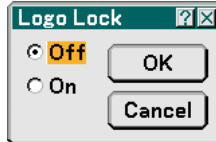
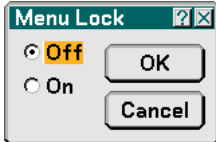

To assign your password:

NOTE: Up to 15 alphanumeric characters can be assigned.

1. Type a password.

Select [On] and press the ENTER button.

The [Enter the Password] screen will be displayed.

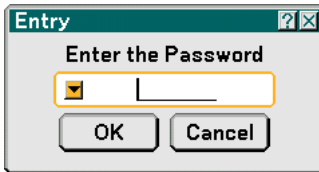

Make sure that  is highlighted and then press the ENTER button.

The Software keyboard appears. Use the Software keyboard to type a password and then highlight [OK] on the [Enter the Password] screen and press the ENTER button.

The [Confirm Password] screen will be displayed.

2. Type the same password again. Highlight [OK] on the [Enter the Password] screen and press the ENTER button.

Your password will be assigned.

[Delete] :

To delete your password:

1. Select [Off] and press the ENTER button. The [Current Password] screen will be displayed.

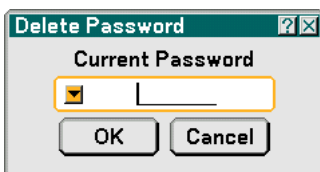

2. Use the Software keyboard to type your password. Highlight [OK] on the [Current Password] screen and then press the ENTER button.

Your password will be deleted.

[Security]

The Security function enables you to protect your projector so that the projector will not project a signal unless you enter a keyword. There is also an option to lock the projector by using a registered PC card* or USB memory* as a protect key. Once you have registered your PC card as a protect key, you are required to insert the registered PC card into the PC card slot of the projector each time you turn on the projector. You can enable the Security function by using a keyword only.

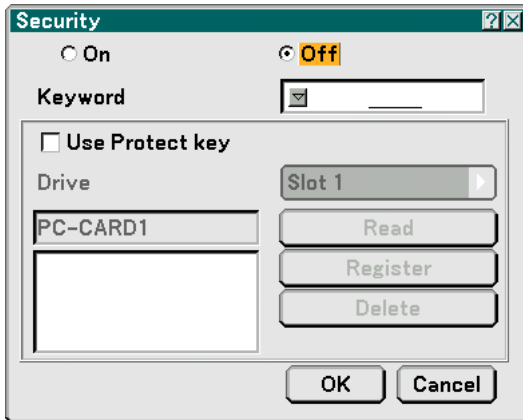

* The projector does not support NTFS formatted flash memory card or USB memory device. Be sure to use a flash memory card or USB memory device formatted with the FAT32, FAT16 or FAT file system. To format your flash memory card or USB memory device in your computer, refer to the document or help file that comes with your Windows.

- On/Off This turns the Security function on or off.
- Keyword Enter an appropriate keyword when you use the Security function. (Up to 10 characters can be used.) The Security function is available only when your keyword is entered.
- Use Protect key Check this box to lock your projector when using a PC card. To use a keyword without a PC card, do not check this box.
- Drive Switches between PC Card slot and USB port (type A).
- Read Reads data from a PC card.
- Register Registers data from the PC card. The Security function is not available unless at least one PC card is registered. (if the [Use Protect key] check box is selected) Up to 5 PC cards can be registered.
- Delete Deletes data of a registered PC card.

To set up a keyword to enable the Security function without using a registered PC card.

1. Use the SELECT ▲▼ button to select [Keyword] and use the software keyboard to enter a keyword.

NOTE: Please make a note of your keyword.

2. Use the SELECT ▲▼ button to select [On] and use the SELECT ▲▼ button to select [OK], then the Security function will be enabled.

An [Are you sure?] message will appear. Use the SELECT ◀▶ button to select [Yes] and press the ENTER button.

The Security function takes effect.

To register a PC card as a protect key.

- 1. Insert a PC card into the PC card slot of the projector.**
- 2. Use the SELECT ▲▼ button to select [Use Protect Key] and press the ENTER button.**
- 3. Use the SELECT ▲▼ button to select [Read] and press the ENTER button.**
Data of the PC card will be read into the projector.
- 4. Use the SELECT ▲▼ button to select [Register] and press the ENTER button.**
Downloaded data will be registered and be displayed in the list window.
- 5. Use the SELECT ▲▼ button to select [Keyword] and use the software keyboard to enter a keyword.**

NOTE: To use a PC card as a protect key, you must also set up a keyword. Please make a note of your keyword.

This completes registration of your PC card.

To enable Security, use the SELECT ▲▼ button to select [On] and use the SELECT ▲▼ button to select [OK] and Security function will be enabled. An [Are you sure?] message will appear. Use the SELECT ◀▶ button and press the ENTER button.

The Security function takes effect.

To turn on the projector when Security is enabled (when using your keyword only).

- 1. Press and hold the POWER button for a minimum of two seconds.**
The projector will be turned on and display a message to the effect that the projector is security-protected.
- 2. Press the MENU button.**
The Release Code input screen will be displayed.
- 3. Enter your keyword in the Release Code input screen.**
You can view the projected image.

NOTE: Do not forget your keyword. However, if you forget your keyword, Dukane or your dealer will provide you with your Release Code. See more information at the end of this section.

To turn on the projector when Security is enabled (when using PC card as a protect key).

- 1. Insert your registered PC card into the PC card slot.**
- 2. Press and hold the POWER button for a minimum of two seconds.**
The projector will turn on and then recognize the PC card. Once the image has been projected, it will stay on without the PC card.
 - *The security disable mode is maintained until the main power is turned off (by setting the main power switch to "O" or unplugging the power cord). In the following cases you will be asked to check the protect key or input the keyword:*
 - (1) When [OK] is selected at an image for which security is set and the power is turned off then back on*
 - (2) When the main power is turned off then back on while the security function is enabled*
 - (3) When you attempt to display an image for which security is set while the security function is enabled*
 - *Blanks (spaces) cannot be used in the Keyword section.*

To delete PC card data you registered.

1. Use the **SELECT ▲▼** button to select **[Delete]** and use the **SELECT ◀** button to select the list window.
2. Use the **SELECT ▲▼** button to select the PC card data you wish to delete.
3. Press the **SELECT ▶** button to select **[Delete]** and press the **ENTER** button.

The PC card data will be deleted.

If you've lost your registered PC card, proceed as follows:

NOTE: Dukane or your dealer will provide you with your Release Code in exchange for your registered keyword and Request Code. See more information at the end of this section.

1. **Press and hold the POWER button for a minimum of two seconds.**
The projector will be turned on and display a message to the effect that the projector is security-protected.
 2. **Press the MENU button.**
The Release Code input screen will be displayed as well as your Request Code (24 alphanumeric characters).
 3. **Enter your Release Code in the Release Code Input screen.**
The projector will turn on.
- * **If the projector is turned on by entering the Release Code, your Security will be disabled.**

NOTE:

- *Some types of PC cards cannot be registered as your protect key.*
 - *It is recommended that you register two or more PC cards in case you lose or damage your registered PC card.*
 - *Formatting your registered PC card will disable your protect key function.*
-
-
-

[Installation]

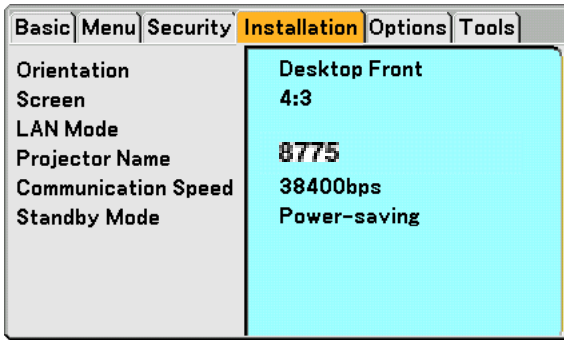

Selecting Projector Orientation [Orientation]

This reorients your image for your type of projection. The options are: desktop front projection, ceiling rear projection, desktop rear projection, and ceiling front projection.

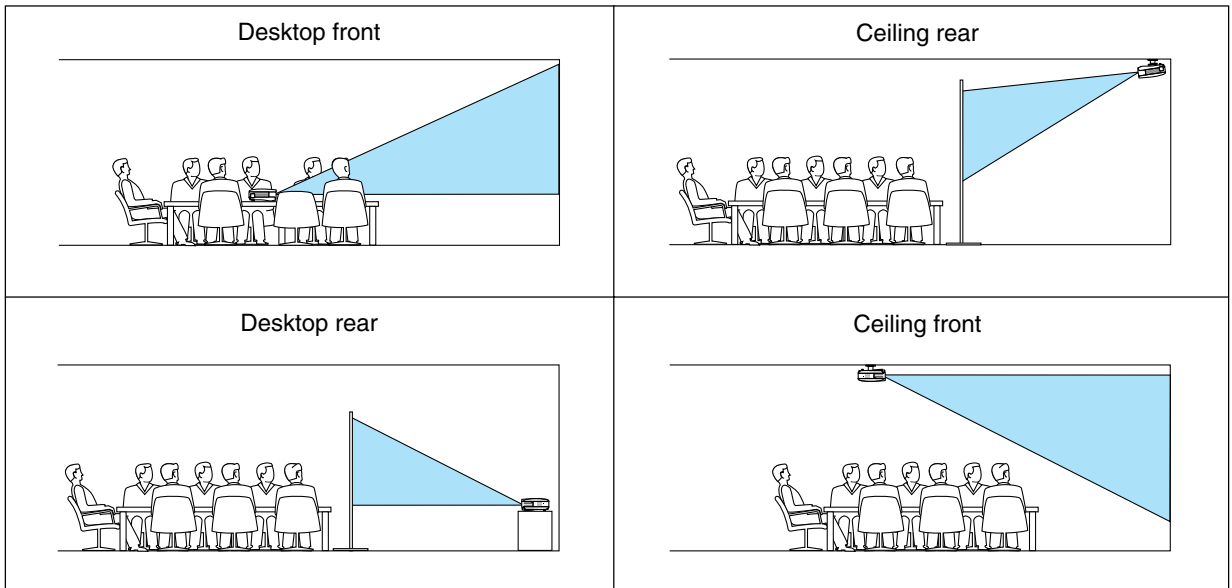

NOTE: Selecting one of the other options than [Desktop Front] will make the [Auto Keystone] unavailable.

Selecting Aspect Ratio and Position for Screen [Screen]

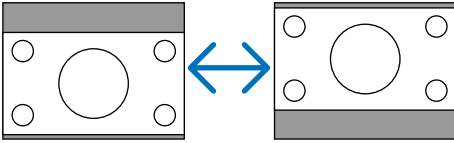

Screen Type Select one of two options: 4:3 Screen or 16:9 Screen for the screen to be used. See also [Aspect Ratio].
(→ page 74)

Position This feature allows you to adjust the vertical position of the image when 16:9 has been selected for the screen type.
When 16:9 has been selected there is black area above and below the image.

NOTE: This option is available only when [16:9] is selected in [Screen Type].

NOTE: During 3D Reform adjustment, [Screen Type] and [Screen Position] may not be available. To make available, first reset the 3D Reform data and then do settings again. Secondly repeat the 3D Reform adjustment. Changing [Screen Type] and [Screen Position] can limit 3D Reform in its adjustable range.

[LAN Mode]

Setting LAN Mode

This feature allows you to set various setting items when the projector is used on your network.

CAUTION

- Consult with your network administrator about these settings.
- Connect a LAN cable (Ethernet cable) to the LAN port (RJ-45). (→ page 19)
- For wireless LAN connection, use the optional wireless LAN card (NWL-100*).
 - * Last digit of the model code varies depending on which country you live in. For more information, visit our Website.
- To use wireless LAN, insert the optional wireless LAN card (NWL-100*) into the PC Card slot.
(→ "Inserting and Removing a PC Card" on page 21)
- Always insert or remove the wireless LAN card when the main power is turned off. Failure to do so may cause projector malfunction or damage to the wireless LAN card. If the projector will not work correctly, turn off the projector, wait 30 seconds, and turn it back on.

Hints on How to Set Up LAN Connection

To configure the projector to communicate on the network using the LAN port (RJ-45) or the optional wireless LAN card:

1. **Select the [Built-in] tab for the LAN port (RJ-45) or the [PC Card] tab for the optional wireless LAN card.**
2. **On the [Built-in] tab or the [PC Card] tab, select a number from the [Profiles] list for your LAN settings. Two settings can be stored in memory for each the LAN port and the wireless LAN card respectively.**
3. **On the [Built-in] tab or the [PC Card] tab, turn on or off [DHCP], specify IP address, Subnet Mask, Gateway and DNS Configuration. Select [OK] and press the ENTER button.**
(→ page 87, 88)

To recall the settings from memory:

After selecting the [Built-in] tab or the [PC Card] tab, select the number from the [Profiles] list. Select [OK] and press the ENTER button. (→ page 87, 88)

To connect a DHCP server:

On the [Built-in] tab or the [PC Card] tab, select [DHCP] and press the ENTER button. A check mark will be placed. Select again and press the ENTER button. The check box will be cleared.

When setting an IP address without using a DHCP server, clear the check box for [DHCP]. (→ page 87, 88)

To set only for wireless LAN (Network Type and WEP):

1. **On the [PC Card] tab, select [Profiles] and then select [Profile 1] or [Profile 2].**
2. **On the [PC Card] tab, select [Advanced] and press the ENTER button. The [Advanced] menu will be displayed.**
(→ page 89, 90)

To select a wireless LAN access point:

1. **On the [PC Card] tab, select [Profiles] and then select [Profile 1] or [Profile 2].**
2. **On the [PC Card] tab, select [Advanced] and press the ENTER button.**
3. **On the Advanced menu, select [Network Type] → [Site Survey] and press the ENTER button.**
4. **Select [Mode] and then select [Infrastructure].**
(→ page 89)

To receive error messages or information on the remaining lamp life via e-mail:

1. On the [Mail] tab, select [Alert Mail] and press the ENTER button. A check mark will be placed.
2. Set [Sender's Address], [SMTP Server Name] and [Recipient's Address]. Select [OK] and press the ENTER button.

(→ page 92)

To execute [Easy Connection] using Image Express Utility 2.0:

The [Easy Connection] is a mode that can abbreviate the troublesome LAN settings when using the Image Express Utility 2.0 and connecting the PC and projector via a wireless LAN.

The Image Express Utility 2.0 is contained on the supplied User Supportware 3 CD-ROM. To use [Easy Connection], select [PC Card] → [Profiles] → [Easy Connection]. (→ page 88)

[Built-in]

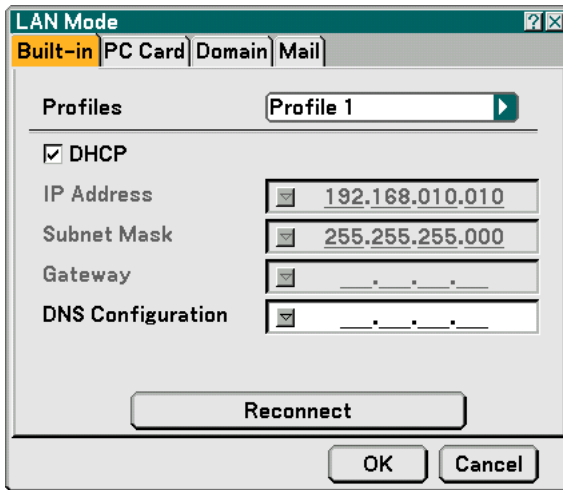

Profiles (for LAN port [RJ-45]):

Up to two settings for the LAN port (RJ-45) can be stored in memory of the projector.

Select [Profile 1] or [Profile 2] and then do settings for [DHCP] and the other options.

After doing this, select [OK] and press the ENTER button. This will store your settings in memory.

DHCP:

Enabling this option automatically assigns an IP address to the projector from your DHCP server.

Disabling this option allows you to register the IP address or subnet mask number obtained from your network administrator.

IP Address Set your IP address. Press to display the software keyboard and type in 12 numeric characters.

Subnet Mask Set your subnet mask number. Press to display the software keyboard and type in 12 numeric characters.

Gateway Set the default gateway of the network connected to the projector. Press to display the software keyboard and type in 12 numeric characters.

DNS Configuration Type in the IP address of DNS server on the network connected to the projector. Twelve numeric characters are used.

Reconnect Use this button to connect the projector to a network.

[PC Card]

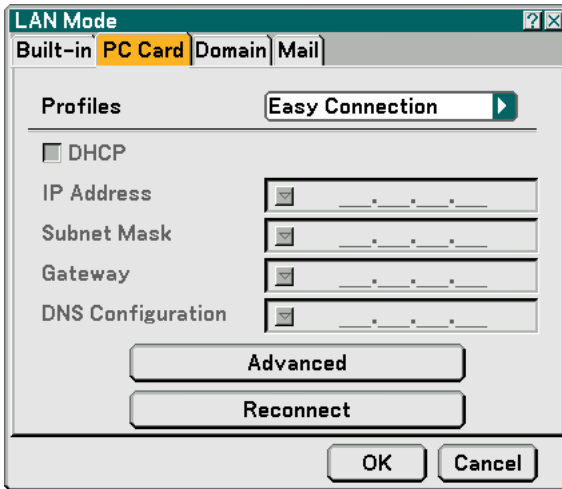

Profiles (for PC Card):

To execute a wireless LAN easily using Image Express Utility 2.0, select [Easy Connection].

Up to two settings for the optional wireless LAN card can be stored in memory of the projector.

Select [Profile 1] or [Profile 2] and then do settings for [DHCP] and the other options.

After doing this, select [OK] and press the ENTER button. This will store your settings in memory.

DHCP:

Place a check mark to automatically assign an IP address to the projector from your DHCP server.

Clear this check box to register the IP address or subnet mask number obtained from your network administrator.

IP Address Set your IP address. Press  to display the software keyboard and type in 12 numeric characters.

Subnet Mask Set your subnet mask number. Press  to display the software keyboard and type in 12 numeric characters.

Gateway Set the default gateway of the network connected to the projector. Press  to display the software keyboard and type in 12 numeric characters.

DNS Configuration Type in the IP address of DNS server on the network connected to the projector. Twelve numeric characters are used.

Advanced Displays the Advanced menu which includes various setting for wireless LAN connection (Network Type and WEP). See the Advanced menu later on.

Reconnect Use this button to connect the projector to a network.

[Advanced] menu
 [Network Type] (required for wireless only)

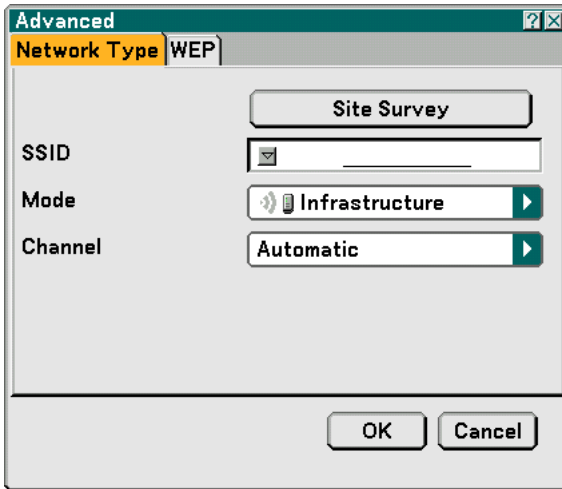

Site Survey:

Displays a list of available SSIDs for wireless LAN on site. Select an SSID which you can access.

To select an SSID, highlight [SSID] and use the SELECT ► to select [OK] and press the ENTER button.

- 📶 : access point
- 📶🖥️ : Ad Hoc PC
- 🔑 : WEP enabled

NOTE: You cannot connect to a device with the SSID for Channel 14 because it is not displayed in the list.

SSID (Network name):

Enter an identifier (SSID) for wireless LAN when selecting [Infrastructure] or [802.11 Ad Hoc] in [Mode]. Communication can be done only with equipment whose SSID matches SSID for your wireless LAN. Up to 32 alphanumeric characters can be used.

NOTE: To disable SSID, select a space (null) or [ANY] (All caps).

Mode:

Select communication method when using wireless LAN.

Infrastructure Select this option when communicating with one or more equipment connected to the wireless or wired LAN network via an access point.

802.11 Ad Hoc Select this option when using the wireless LAN to directly communicate with a computer in peer-to-peer mode. This is a method that meets the IEEE802.11 wireless standard.

*NOTE: When in Ad Hoc mode, only 802.11b is available for communication method.
 Data transmission speed in Ad Hoc mode is limited up to 11Mbps.*

Channel:

Select a channel. There are 14 options available.

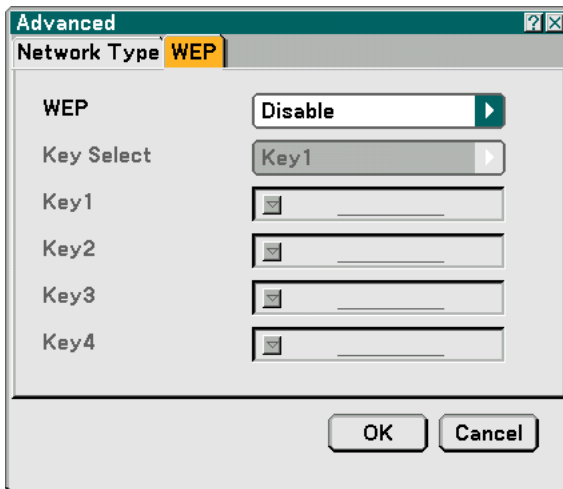
[WEP] (required for wireless only)

Select this option whether using the WEP (Wired Equivalent Privacy) key for encryption or not. To use encryption, specify WEP key.

Disable Will not turn on the encryption feature. Your communications may be monitored by someone.

64bit Uses 64-bit datalength for secure transmission.

128bit Uses 128-bit datalength for secure transmission. This option will increase privacy and security when compared to use of 64-bit datalength encryption.

152bit Uses 152-bit datalength for secure transmission. This option will increase privacy and security when compared to use of 128-bit datalength encryption.

NOTE:

- The WEP settings must be the same as communication devices such as PC or access point in your wireless network.
- When you use WEP, your image transmission speed will slow down.

Key Select:

Selects one key from the four keys below when selecting [64bit], [128bit] or [152bit] in [WEP].

Key1-4:

Enter encryption key when selecting [64bit], [128bit] or [152bit] in [WEP].

Up to 5 characters can be set in 64 bit, up to 13 characters in 128 bit and up to 16 characters in 152 bit. Press the [HEX] button to change to [ASCII] to set the key in ASCII digit. You can toggle this button between [ASCII] and [HEX].

The key can also be set in hexadecimal digit.

* Enter 0X(numeral and alphabet respectively) right in front of your key code.

* Hexadecimal uses 0 to 9 and A to F.

* When setting in a hexadecimal digit, up to 10 characters can be set in 64 bit, up to 26 characters in 128 bit and up to 32 characters in 152 bit.

Using Software Keyboard to enter an encryption key

1. Select one of [Key 1], [Key 2], [Key 3] and [Key 4] and press the ENTER button.
The software keyboard will be displayed.

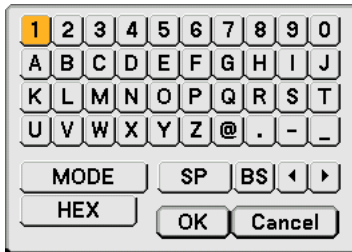

2. Use the SELECT ▲▼◀▶ button to select one key and press the ENTER button.
3. After finishing entering the WEP key, use the SELECT ▲▼◀▶ button to select [OK] and press the ENTER button.
The software keyboard will disappear.

[Domain]

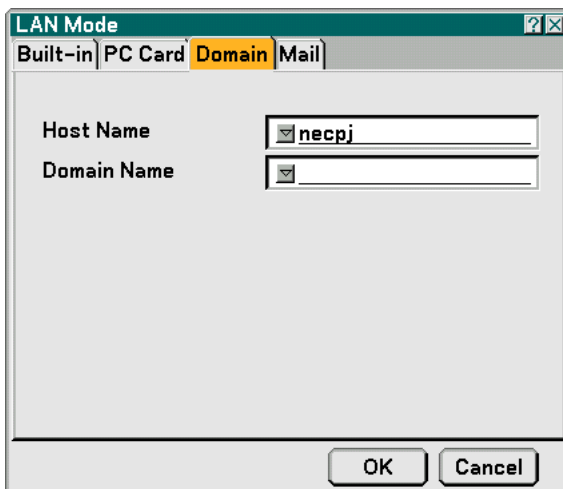

LAN Mode

Built-in | PC Card | **Domain** | Mail

Host Name:

Domain Name:

OK Cancel

Host Name Type in a hostname. Up to 60 alphanumeric characters can be used.

Domain Name Type in domain name of the network connected to the projector. Up to 60 alphanumeric characters can be used.

[Mail]

Alert Mail:

Checking this box enables Alert Mail feature.

This option notifies your computer of an error message via e-mail when using wireless or wired LAN. The error message will be notified when the projector lamp has reached the end of its usable life or an error occurs in the projector.

Sample of a message sent from the projector:

The lamp is at the end of its usable life. Please replace the lamp.

Projector Name: X X X X

Lamp Hours Used: xxxx [H]

Filter Hours Used: xxxx [H]

Projector Hours Used: xxxxxx [H]

Sender's Address:

Specify the senders address. Use the Software keyboard. Up to 60 alphanumeric and symbols characters can be used. See "Using Software Keyboard" in Appendix for more details.

SMTP Server Name:

Type in the SMTP server name to be connected to the projector. Up to 60 alphanumeric characters can be used.

Recipient's Address 1 to 3:

Type in your recipient's address. Up to 60 alphanumeric and symbols characters can be used.

Test Mail:

Send a test mail to check if your settings are correct.

NOTE:

- If you entered an incorrect address in a test, you may not receive an Alert mail. Should this happen, check if the Recipient's Address is correctly set.
- Unless any one of the [Sender's Address], [SMTP Server's Name] or [Recipient's Address 1-3] is selected, [Test Mail] is not available.
- Be sure to highlight [OK] and press the ENTER button before executing [Test Mail].

NOTE: To use the Mail Alert feature on wireless LAN connection, select [Infrastructure] for [Mode] in [Network Type].

[Projector Name]

Specify a unique projector name. Press  to display the software keyboard and type in. Up to 16 alphanumeric characters can be used. After entering a name, select [OK] and press the ENTER button.

Using Software Keyboard

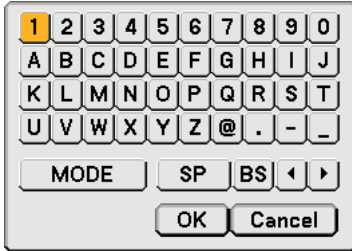

1 to 0 and

Characters Use to type in password or keyword.

MODE Selects one of three modes for alphabet and special characters.

SP Inserts a space

BS Deletes one character backward

◀ Returns to the previous

▶ Advances to the next

OK Executes the selection

Cancel Cancels the selection

Selecting Communication Speed [Communication Speed]

This feature sets the baud rate of the PC Control port (Mini D-Sub 9 Pin). It supports data rates from 4800 to 38400 bps. The default is 38400 bps. Select the appropriate baud rate for your equipment to be connected (depending on the equipment, a lower baud rate may be recommended for long cable runs).

Your selected communication speed will not be affected even when [Reset] is done from the menu.

Selecting Power-saving in [Standby Mode]

The projector has two standby modes: [Normal] and [Power-saving].

Power-saving mode is the mode that allows you to put the projector in the power-saving condition which consumes less power than the Normal mode. The projector is preset for Normal mode at the factory.

NOTE:

- The HTTP server functions are not available during Power-saving mode.
- The MONITOR OUT function is not available during Power-saving mode.
- Control through the PC Control connector and LAN mode is not available during Power-saving mode. For PC control and LAN mode of the projector it is recommended to leave the projector in the Normal mode.
- Normal mode Power indicator: Orange light/ Status indicator: Green light
Power-saving mode Power indicator: Orange light/Status indicator: Off

(→ page 107)

[Options]

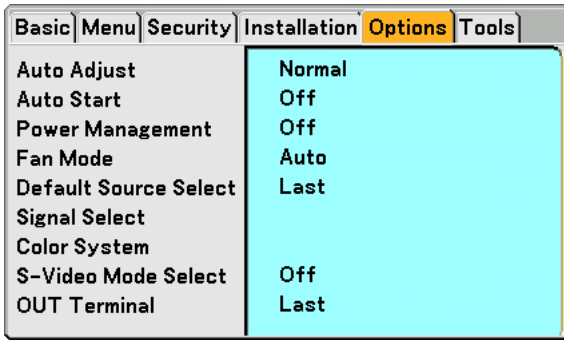

Setting Auto Adjust [Auto Adjust]

This feature sets the Auto Adjust mode so that the RGB image can be automatically or manually adjusted for noise and stability. You can automatically make adjustment in two ways: [Normal] and [Fine].

- Off The RGB image will not be automatically adjusted.
You can manually optimize the RGB image.
- Normal Default setting. The RGB image will be automatically adjusted. Normally select this option.
- Fine Select this option if fine adjustment is needed. It takes more time to switch to the source than when [Normal] is selected.

Enabling Auto Start [Auto Start]

Turns the projector on automatically when the power cable is inserted into an active power outlet and the main power switch is turned on. This eliminates the need to always use the POWER (ON/STANDBY) button on the remote control or projector cabinet.

To use the Auto Start function, you must first press the main power switch to the position "On" before plugging the power cable.

Enabling Power Management [Power Management]

When this option is selected you can enable the projector to automatically turn off (at the selected time: 5min., 10min., 20min., 30min.) if there is no signal received by any input.

Enabling High Speed Fan Mode [Fan Mode]

This option allows you to select two modes for fan speed: Auto mode and High speed mode.

- Auto The built-in fans automatically run at a variable speed according to the internal temperature.
- High The built-in fans run at high speed.

When you wish to cool down the temperature inside the projector quickly, select [High].

NOTE: Select High mode if you continue to use the projector for consecutive days.

Selecting Default Source [Default Source Select]

You can set the projector to default to any one of its inputs each time the projector is turned on.

- Last Sets the projector to default to the previous or last active input each time the projector is turned on.
- Auto Searches for an active source in order of Computer1 → Computer2 → Computer3 (LT380 only) → Component → Video → S-Video → Viewer → Computer1 and displays the first found source.
- Select Displays the selected source input every time the projector is started up. Select an input from the pull-down menu.

Selecting Signal Format [Signal Select]

Computer 1/2

Allows you to set [Computer 1] and [Computer 2] to automatically detect an incoming RGB or component source such as a computer or DVD player. However there may be some RGB and component signals that the projector is unable to detect. In this case, select [RGB] or [Component].

Select [Scart] in COMPUTER 1 for the European Scart signal.

Component

Select a signal type from the COMPONENT (Y, Cb/Pb, Cr/Pr) connectors.

Component..... Selects a component signal.

Video Selects a component signal such as Y/Cb/Cr or Y/Pb/Pr.

NOTE: When using the "Y" connector of the COMPONENT connectors to display a Video signal, select "Video".

Selecting [Color System]

This feature enables you to select video standards manually.

Normally select [Auto]. Select the video standard from the pulldown menu. This must be done for Component (Video), Video and S-Video Connector separately.

Selecting S-Video Mode [S-Video Mode Select]

This feature is used to select the S-Video signal detection mode.

This allows identifying of the S-Video signals with different aspect ratio (16:9 and 4:3).

Off Does not identify any S-Video signal.

S2 Identifies the 16:9 or 4:3 signal.

NOTE: The Aspect Ratio is not available when S2 signal is detected.

Setting MONITOR OUT Connector [OUT Terminal]

This option allows you to determine which RGB or component source is output from the MONITOR OUT connector during Standby mode.

Last The signal from the last COMPUTER 1, COMPUTER 2 or COMPONENT input will be output to the MONITOR OUT connector.

Computer 1, 2 The signal from the COMPUTER1, COMPUTER2 or Component input will be output to the MONITOR OUT connector.

Component..... The signal from the COMPONENT input will be output to the MONITOR OUT connectors.

NOTE: The MONITOR OUT function is not available during Power-saving mode

[Tools]

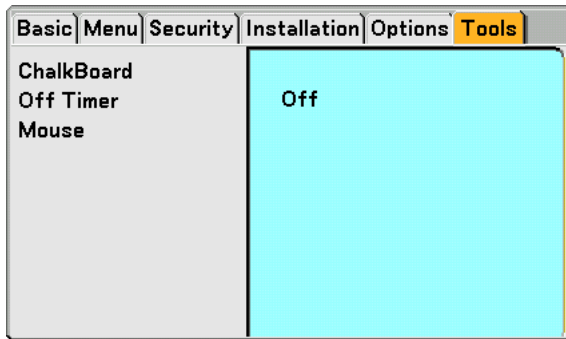

Selecting the ChalkBoard [ChalkBoard]

This option displays the ChalkBoard tool bar.

The ChalkBoard feature allows you to write and draw messages on a projected image. (→ page 41)

NOTE: The ChalkBoard feature is available only when a USB mouse is used.

Using Off Timer [Off Timer]

1. Select your desired time between 30 minutes and 16 hours: Off, 0:30, 1:00, 2:00, 4:00, 8:00, 12:00, 16:00.
2. Select [OK] and press the ENTER button on the remote control.
3. The remaining time starts counting down.
4. The projector will turn off after the countdown is complete.

NOTE:

- To cancel the preset time, set [Off] for the preset time or turn off the power.
 - When the remaining time reaches 3 minutes before the projector is turned off, the [Projector will turn off in 3 minutes] message will be displayed on the bottom of the screen.
-

Setting Mouse Pointer, Button and Sensitivity [Mouse]

This option lets you to change your USB mouse settings. The mouse settings feature is available for USB mouse only. Choose the settings you want:

Mouse Pointer Pointer 1 - 9

Mouse Button [Right Hand] or [Left Hand]

Mouse Sensitivity .. [Fast], [Medium] or [Slow]

7 Menu Descriptions & Functions [Information]

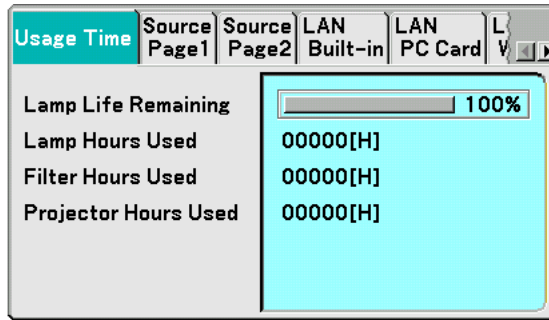

Displays the lamp and the projector usage hours, the status of the current signal and settings and LAN settings. This dialog box has seven pages.

The information included are as follows:

[Usage Time]

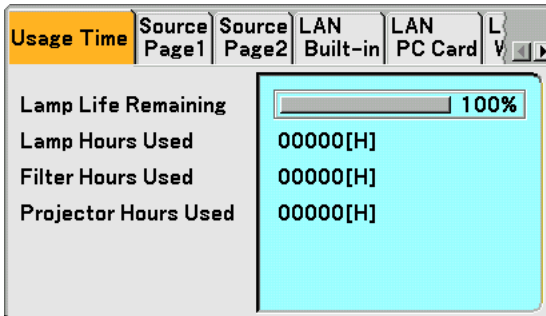

Lamp Life Remaining (%)

Lamp Hours Used (H)

Filter Hours Used (H)

Projector Hours Used (H)

NOTE: The progress indicator shows the percentage of remaining lamp life. The value informs you of the amount of lamp, filter and projector usage respectively.

[Source Page1]

Usage Time	Source Page1	Source Page2	LAN Built-in	LAN PC Card	L V
Input Terminal	Video				
Signal Type	Video				
Video Type	NTSC3.58				
Source Name	NTSC3.58				
Entry No.	3				

Input Terminal Signal Type
 Video Type Source Name
 Entry No.

[Source Page2]

Usage Time	Source Page1	Source Page2	LAN Built-in	LAN PC Card	L V
Horizontal Frequency	15.73[kHz]				
Vertical Frequency	59.93[Hz]				
Sync Type	---				
Sync Polarity	---				
Scan Type	Non-Interlace				

Horizontal Frequency Vertical Frequency
 Sync Type Sync Polarity
 Scan Type

[LAN Built-in]

Usage Time	Source Page1	Source Page2	LAN Built-in	LAN PC Card	L V
IP Address	192.168. 10. 10				
Subnet Mask	255.255.255. 0				
Gateway	. . .				
MAC Address	00-02-78-E0-8C-B4				

This page shows information on settings for the LAN port (RJ-45)

IP Address Indicates the IP address of the projector when the LAN port (RJ-45) is used.

Subnet Mask Indicates the subnet mask of the projector when the LAN port (RJ-45) is used

Gateway Indicates the gateway of the network connected to the projector when the LAN port (RJ-45) is used.

MAC Address Indicates the MAC address of the LAN port (RJ-45).

[LAN PC Card]

Usage Time	Source Page1	Source Page2	LAN Built-in	LAN PC Card	L V
IP Address	192.168. 10. 11				
Subnet Mask	255.255.255. 0				
Gateway	. . .				
MAC Address	00-02-78-E0-8C-B4				

This page shows information on settings for the optional wireless LAN card

IP Address Indicates the IP address of the projector when the optional wireless LAN card is used.

Subnet Mask Indicates the subnet mask of the projector when the optional wireless LAN card is used.

Gateway Indicates the gateway of the network connected to the projector when the optional wireless LAN card is used.

MAC Address Indicates the MAC address of the optional wireless LAN card.

[LAN Wireless]

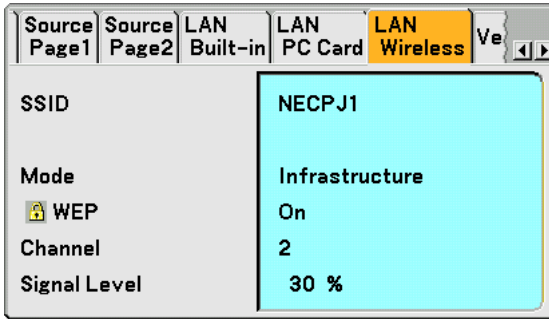

This page shows information on settings for WEP key for encryption.

- SSID Indicates the identifier (SSID) for your wireless LAN.
- Mode Indicates that [Infrastructure] or [802.11 Ad Hoc] is selected for your communication method
- WEP Indicates your selected datalength encryption: On or Off
- Channel Indicates the channel you selected in the [Site Survey]. The channel must match for all wireless devices communicating on your wireless LAN.
- Signal Level Indicates receiving condition of radio signal level while you are using a wireless LAN connection (Only when PC Card is used)

[Version]

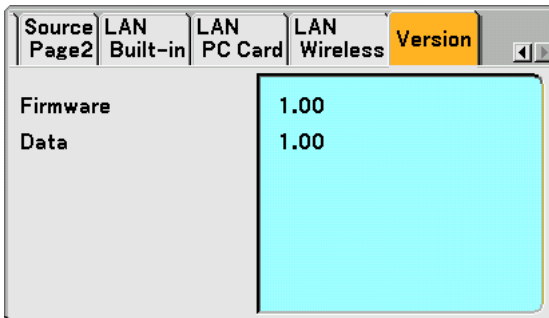

Firmware
Data

8 Menu Descriptions & Functions [Reset]



Returning to Factory Default

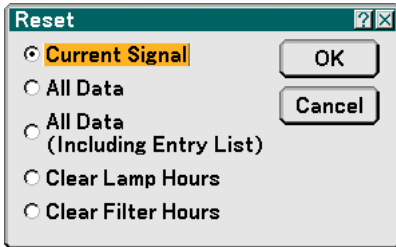

The Reset feature allows you to change adjustments and settings to the factory preset for sources by the following methods:

[Current Signal]

Resets the adjustments for the current signal to the factory preset levels.
All the items in [Adjust] can be reset.

[All Data]

Reset all the adjustments and settings for all the signals to the factory preset except [Entry List], [Language], [Background], [Control Panel Lock], [Menu Lock], [Logo Lock], [Security], [LAN Mode], [Projector Name], [Communication Speed], [Standby Mode], [Lamp Life Remaining], [Lamp Hours Used], [Filter Hours Used] and [Projector Hours Used].

[All Data (Including Entry List)]

Reset all the adjustments and settings for all the signals to the factory preset except [Language], [Background], [Control Panel Lock], [Menu Lock], [Logo Lock], [Security], [LAN Mode], [Projector Name], [Communication Speed], [Standby Mode], [Lamp Life Remaining], [Lamp Hours Used], [Filter Hours Used] and [Projector Hours Used].
Also deletes all the signals in the [Entry List] and returns to the factory preset.

NOTE: Locked signals in Entry List cannot be reset.

Clearing Lamp Hour Meter [Clear Lamp Hours]

Resets the lamp clock back to zero.

NOTE: Elapsed time of the lamp use will not be affected even when [Reset] is done from the menu.

NOTE: The projector will turn off and go into standby mode after 2100 hours (up to 3100 hours in Eco mode) of service. In this condition you cannot clear the lamp hour meter on the menu. If this happens, press the HELP button on the remote control for 10 seconds to reset the lamp clock back to zero. Do this only after replacing the lamp.

Resetting the Filter Usage Hours [Clear Filter Hours]

Resets the filter usage back to zero.

NOTE: Elapsed time of the filter use will not be affected even when [Reset] is done from the menu.

7. Maintenance

This section describes the simple maintenance procedures you should follow to clean the filter and replace the lamp.

① Cleaning or Replacing the Filter

The air-filter sponge keeps dust and dirt from getting inside the projector and should be cleaned after every 100 hours of operation (more often in dusty conditions). If the filter is dirty or clogged, your projector may overheat.

CAUTION

- Turn off the projector, turn off the main power switch and unplug the projector before replacing the filter.
- Only clean the outside of the filter cover with a vacuum cleaner.
- Do not attempt to operate the projector without the filter cover.

To clean the air-filter:

Vacuum the filter-through the filter cover.

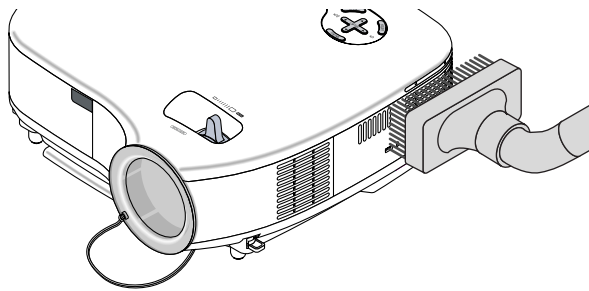

To reset the filter usage time, from the menu, select [Reset] → [Clear Filter Hours].
(→ page 101 for resetting the filter usage time)

To replace the filter (sponge):

1. Remove the filter cover by pushing down on the catch of the cover until you feel it detach.

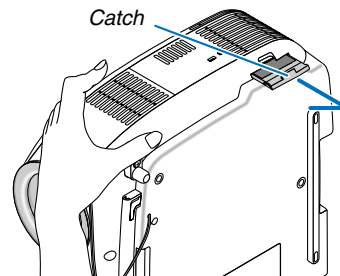
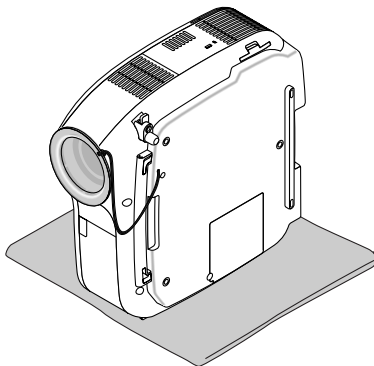

2. Gently peel off the filter (sponge) and replace it with the new one.

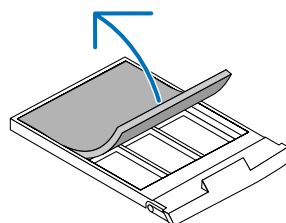
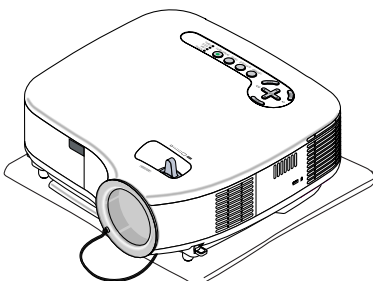

3. Reinstall the new filter cover.

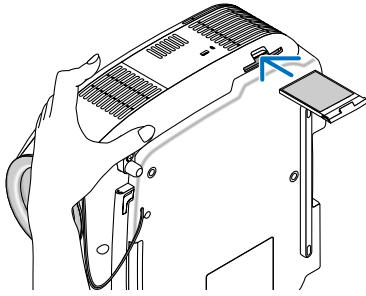

NOTE: Do not wash the filter with soap and water. Soap and water will damage the filter membrane. Before replacing the filter, remove dust and dirt from the projector cabinet. Keep out dust and dirt during filter replacement.

NOTE: When you replace the lamp, it is also wise to replace the filter. The filter comes in the same package with your replacement lamp.

② Cleaning the Cabinet and the Lens

1. Turn off the projector before cleaning.
2. Clean the cabinet periodically with a damp cloth. If heavily soiled, use a mild detergent. Never use strong detergents or solvents such as alcohol or thinner.
3. Use a blower or lens paper to clean the lens, and be careful not to scratch or mar the lens.

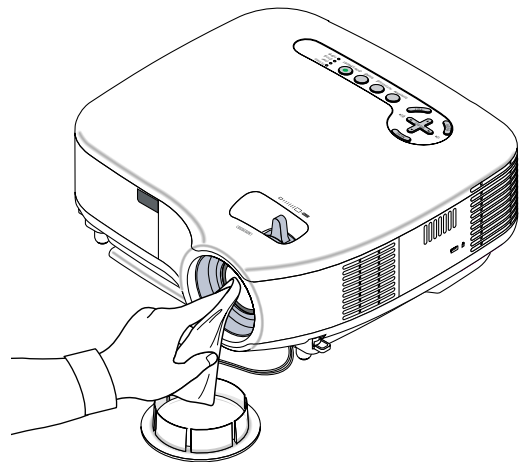
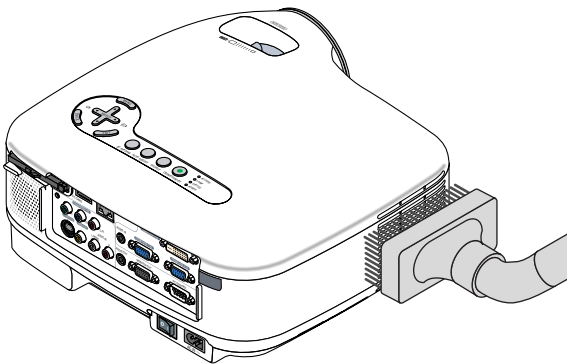

③ Replacing the Lamp

After your lamp has been operating for 2000 hours (up to 3000 hours in Eco mode) or longer, the LAMP indicator in the cabinet will blink red and the message **[The lamp has reached the end of its usable life. Please replace the lamp.]** will appear. Even though the lamp may still be working, replace it at 2000 (up to 3000 hours in Eco mode) hours to maintain optimal projector performance. After replacing the lamp, be sure to clear the lamp hour meter. (→ page 101)

CAUTION

- DO NOT TOUCH THE LAMP immediately after it has been used. It will be extremely hot. Turn the projector off, wait 30 seconds, turn off the main power switch and then disconnect the power cable. Allow at least one hour for the lamp to cool before handling.
- DO NOT REMOVE ANY SCREWS except two lamp case screws. You could receive an electric shock.
- Do not break the glass on the lamp housing.
Keep finger prints off the glass surface on the lamp housing. Leaving finger prints on the glass surface might cause an unwanted shadow and poor picture quality.
- The projector will turn off and go into standby mode after 2100 (up to 3100 hours in Eco mode) hours of service. If this happens, be sure to replace the lamp. If you continue to use the lamp after 2000 hours (up to 3000 hours in Eco mode) of use, the lamp bulb may shatter, and pieces of glass may be scattered in the lamp case. Do not touch them as the pieces of glass may cause injury. If this happens, contact your dealer for lamp replacement.

To replace the lamp:

Optional lamp and tools needed for replacement:

- Replacement lamp 456-8775.
- Phillips screwdriver or equivalent

1. Place the projector on a soft cloth and turn it over to access the lamp cover on the bottom.

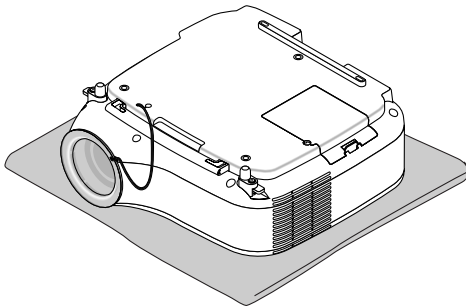

2. Use a Phillips screwdriver to push and release the tab.

Push up and remove the lamp cover.

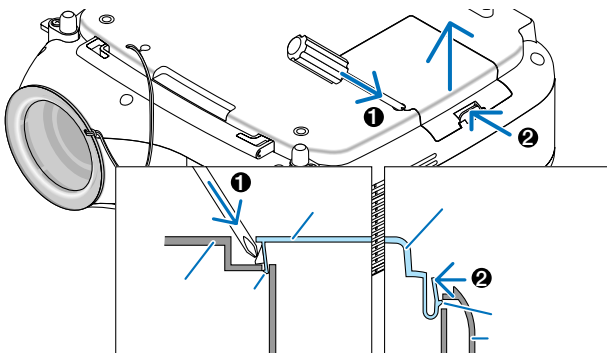

3. Loosen the two screws securing the lamp housing until the phillips screwdriver goes into a freewheeling condition. The two screws are not removable. Remove the lamp housing by holding it.

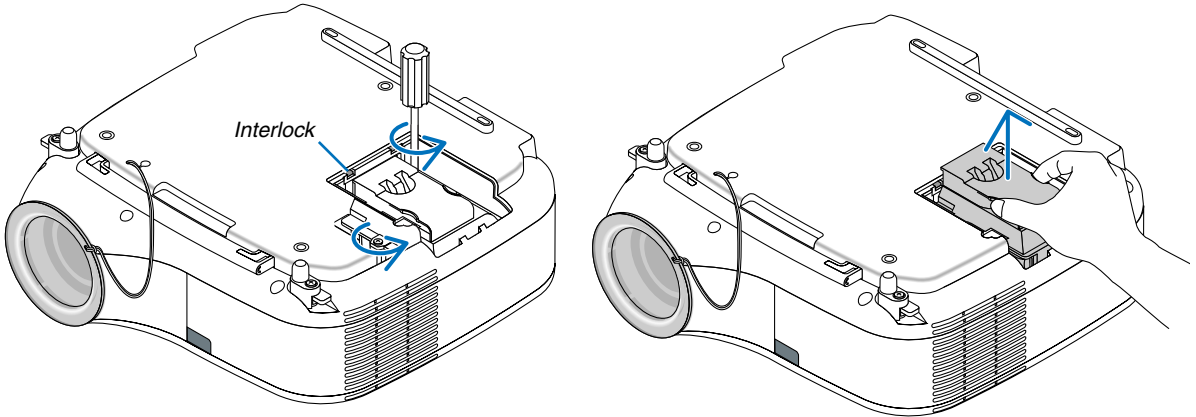

NOTE: There is an interlock on this case to prevent the risk of electrical shock. Do not attempt to circumvent this interlock.

4. Insert a new lamp housing until the lamp housing is plugged into the socket.

CAUTION

Do not use a lamp other than the replacement lamp 456-8775.
Order this from your dealer.

Secure it in place with the two screws.
Be sure to tighten the screws.

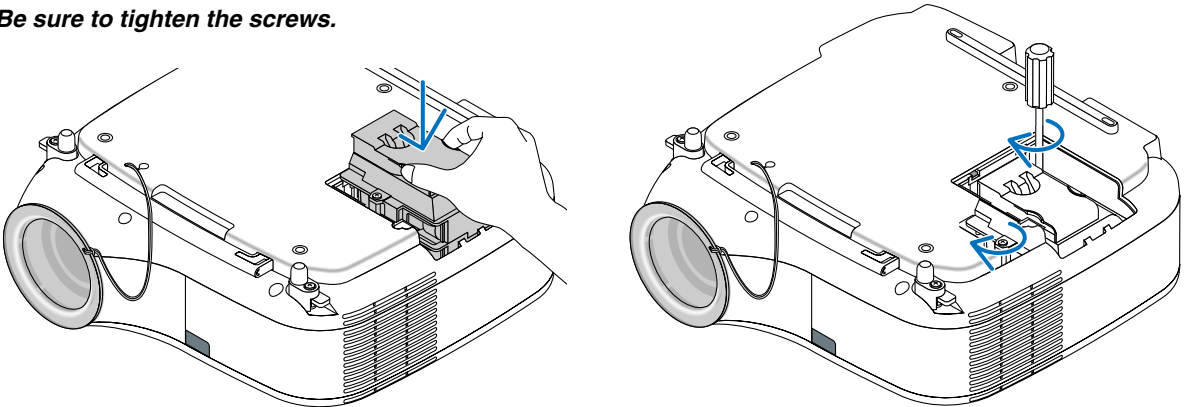

5. Reattach the lamp cover.
Slip the lamp cover back until it snaps into place.

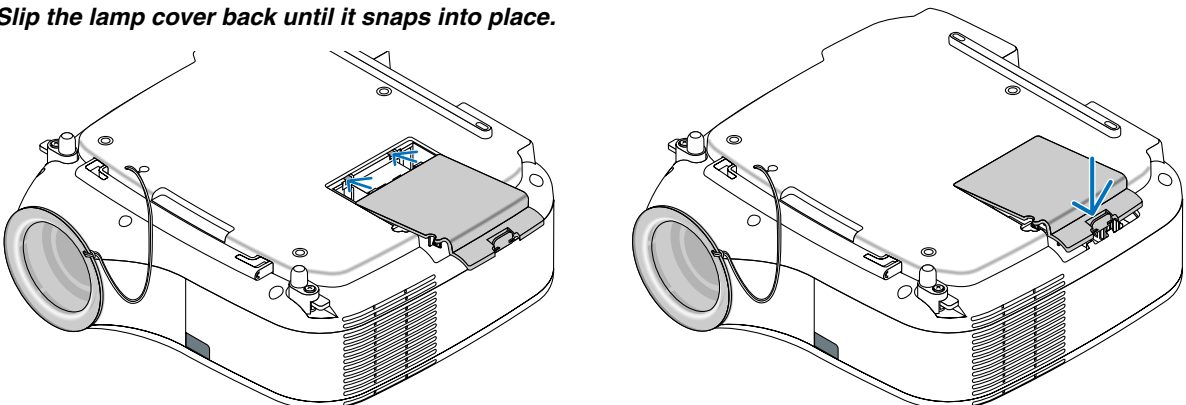

6. Connect the supplied power cable, turn on the Main Power switch and turn on the projector.

7. Finally, select the menu → [Reset] → [Clear Lamp Hours] to reset the lamp usage hours.

NOTE: When the lamp exceeds 2100 hours (up to 3100 hours in Eco mode) of service, the projector cannot turn on and the menu is not displayed.

If this happens, press the HELP button on the remote control for 10 seconds to reset the lamp clock back to zero.

When the lamp time clock is reset to zero, the LAMP indicator goes out.

8. Appendix

① Troubleshooting

This section helps you resolve problems you may encounter while setting up or using the projector.

Indicator Messages

Power Indicator

Indicator Condition			Projector Condition	Note
Off			The main power is off	–
Blinking light	Green	0.5 sec On, 0.5 sec Off	The projector is getting ready to turn on.	Wait for a moment.
		2.5 sec On, 0.5 sec Off	Off Timer is activated.	–
	Orange	0.5 sec On, 0.5 sec Off	The projector is cooling down.	Wait for a moment.
Steady light	Green		The projector is turned on.	–
	Orange		The projector is in Standby.	–

Status Indicator

Indicator Condition			Projector Condition	Note
Off			Normal	–
Blinking light	Red	1 cycle (0.5 sec On, 2.5 sec Off)	Lamp cover error	Replace the lamp cover correctly. (→ page 105)
		2 cycle (0.5 sec On, 0.5 sec Off)	Temperature error	The projector is overheated. Move the projector to a cooler location.
		3 cycle (0.5 sec On, 0.5 sec Off)	Power error	Power unit will not work correctly.
		4 cycle (0.5 sec On, 0.5 sec Off)	Fan error	Fans will not work correctly.
		6 cycle (0.5 sec On, 0.5 sec Off)	Lamp error	Lamp fails to light. Wait a full minute and then turn on again.
	Green		Re-firing the lamp	The projector is re-firing.
	Orange	1 cycle(0.5 sec On, 2.5 sec Off)	Network conflict	Both the built-in LAN and the wireless LAN cannot be connected to the same network at the same time. To use both built-in LAN and wireless LAN at the same time, connect them to different networks. (→ page 87)
Steady light	Orange		Control Panel Lock is on	You have pressed cabinet button when Control Panel Lock is on. (→ page 79)
	Green		The projector is in Standby.	–

Lamp Indicator

Indicator Condition			Projector Condition	Note
Off			Normal	–
Blinking light	Red		Lamp has reached its end of life. Lamp replacement message will be displayed.	Replace the lamp. (→ page 104)
Steady light	Red		Lamp has been used beyond its limit. The projector will not turn on until the lamp is replaced.	Replace the lamp. (→ page 104)
	Green		Lamp is in Eco mode	–

Common Problems & Solutions (→ "Power/Status/Lamp Indicator" on page 107)

Problem	Check These Items
Does not turn on	<ul style="list-style-type: none"> • Check that the power cable is plugged in and that the power button on the projector cabinet or the remote control is on. (→ page 23, 24) • Ensure that the lamp cover is installed correctly. (→ page 105) • Check to see if the projector has overheated. If there is insufficient ventilation around the projector or if the room where you are presenting is particularly warm, move the projector to a cooler location. • Check to see if the lamp usage exceeds 2100 hours (up to 3100 hours : Eco mode). If so, replace the lamp. After replacing the lamp, reset the lamp hours used. (→ page 101) • The lamp may fail to light. Wait a full minute and then turn on the power again.
Will turn off	<ul style="list-style-type: none"> • Ensure that the Power Management or Off Timer is off. (→ page 94, 96)
No picture	<ul style="list-style-type: none"> • Use the SOURCE button on the projector cabinet or the VIDEO, the S-VIDEO, the COMPUTER 1, the COMPUTER 2, the COMPUTER 3 (LT380 only), COMPONENT, the VIEWER or the LAN button on the remote control to select your source. (→ page 26) • Ensure your cables are connected properly. • Use menus to adjust the brightness and contrast. (→ page 71) • Check to see if the image is muted. (→ page 34) • Remove the lens cap. • Reset the settings or adjustments to factory preset levels using the Reset in the Menu. (→ page 101) • Enter your registered keyword if the Security function is enabled. (→ page 42) • Be sure to connect the projector and notebook PC while the projector is in standby mode and before turning on the power to the notebook PC. In most cases the output signal from the notebook PC is not turned on unless connected to the projector before being powered up. * If the screen goes blank while using your remote control, it may be the result of the computer's screen-saver or power management software. • See also the next page.
Color tone or hue is unusual	<ul style="list-style-type: none"> • Check if an appropriate color is selected in [Wall Color]. If not, select an appropriate option. (→ page 78) • Adjust [Hue] in [Adjust]. (→ page 71)
Image isn't square to the screen	<ul style="list-style-type: none"> • Reposition the projector to improve its angle to the screen. (→ page 27) • Use the 3DReform function to correct the trapezoid distortion. (→ page 29)
Picture is blurred	<ul style="list-style-type: none"> • Adjust the focus. (→ page 28) • Reposition the projector to improve its angle to the screen. (→ page 27) • Ensure that the distance between the projector and screen is within the adjustment range of the lens. (→ page 11) • Condensation may form on the lens if the projector is cold, brought into a warm place and is then turned on. Should this happen, let the projector stand until there is no condensation on the lens.
Image is scrolling vertically, horizontally or both	<ul style="list-style-type: none"> • Use the SOURCE button on the projector cabinet or the VIDEO, the S-VIDEO, the COMPUTER 1, the COMPUTER 2, the COMPUTER 3 (LT380 only), COMPONENT, the VIEWER or the LAN button on the remote control to select your source (Video, S-Video, Computer, Component, Viewer or LAN). (→ page 26) • Adjust the computer image manually with the [Clock]/[Phase] in [Adjust] → [Image Options]. (→ page 72)
Remote control does not work	<ul style="list-style-type: none"> • Install new batteries. (→ page 9) • Make sure there are no obstacles between you and the projector. • Stand within 22 feet (7 m) of the projector. (→ page 9)
Indicator is lit or blinking	<ul style="list-style-type: none"> • See the POWER/STATUS/LAMP Indicator. (→ page 107)
Vertical stripes in RGB mode	<ul style="list-style-type: none"> • Press the AUTO ADJUST button on the projector cabinet or the AUTO ADJ. button on the remote control. (→ page 31) • Adjust the computer image manually with the [Clock]/[Phase] in [Adjust] → [Image Options]. (→ page 72)
USB mouse does not work	<ul style="list-style-type: none"> • Make sure that your USB mouse is properly connected to the projector. The projector may not support some brands of a USB mouse.

For more information contact your dealer.

If there is no picture, or the picture is not displayed correctly.

- Power on process for the projector and the PC.

Be sure to connect the projector and notebook PC while the projector is in standby mode and before turning on the power to the notebook PC.

In most cases the output signal from the notebook PC is not turned on unless connected to the projector before being powered up.

NOTE: You can check the horizontal frequency of the current signal in the projector's menu under Information. If it reads "0kHz", this means there is no signal being output from the computer. See page 98 or go to next step.

- Enabling the computer's external display.

Displaying an image on the notebook PC's screen does not necessarily mean it outputs a signal to the projector. When using a PC compatible laptop, a combination of function keys will enable/disable the external display. Usually, the combination of the 'Fn' key along with one of the 12 function keys gets the external display to come on or off. For example, NEC laptops use Fn + F3, while Dell laptops use Fn + F8 key combinations to toggle through external display selections.

- Non-standard signal output from the computer

If the output signal from a notebook PC is not an industry standard, the projected image may not be displayed correctly. Should this happen, deactivate the notebook PC's LCD screen when the projector display is in use. Each notebook PC has a different way of deactivate/reactivate the local LCD screens as described in the previous step. Refer to your computer's documentation for detailed information.

- Image displayed is incorrect when using a Macintosh

When using a Macintosh with the projector, set the DIPswitch of the Mac adapter (not supplied with the projector) according to your resolution. After setting, restart your Macintosh for the changes to take affect.

For setting display modes other than those supported by your Macintosh and the projector, changing the DIP switch on a Mac adapter may bounce an image slightly or may display nothing. Should this happen, set the DIP switch to the 13" fixed mode and then restart your Macintosh. After that, restore the DIP switches to a displayable mode and then restart the Macintosh again.

NOTE: A Video Adapter cable manufactured by Apple Computer is needed for a PowerBook which does not have a mini D-Sub 15-pin connector.

- Mirroring on a PowerBook

* When using the projector with a Macintosh PowerBook, output may not be set to 1024 x 768 unless "mirroring" is off on your PowerBook. Refer to owner's manual supplied with your Macintosh computer for mirroring.

- Folders or icons are hidden on the Macintosh screen

Folders or icons may not be seen on the screen. Should this happen, select [View] ->[Arrange] from the Apple menu and arrange icons.

② Specifications

This section provides technical information about the projector's performance.

Model Number	8774/8775
Optical	
LCD Panel	8775: 0.8" p-Si TFT active-matrix with Micro Lens Array 8774: 0.7" p-Si TFT active-matrix with Micro Lens Array
Resolution	1024 × 768 pixels* up to UXGA with Advanced AccuBlend
Lens	Manual zoom and focus: 8775: F1.7 - 2.0 f=24.2 - 29.0 mm 8774: F1.7 - 2.0 f=21.6 - 25.9 mm
Lamp	200 W DC (152 W DC in Eco mode)
Image Size	21 inches - 300 inches (0.53 m - 7.62 m) diagonal
Projection Distance	8775: 2.33 - 35.89 ft / 0.71 -10.94 m 8774: 2.36 -35.66 ft / 0.72 -10.87 m
Projection Angle	8775: 10.3° - 11.2° (wide) / 8.5° - 9.2° (tele) 8774: 11.5° - 12.1° (wide) / 9.5° - 10.0° (tele)
Electrical	
Inputs	2 Analog RGB (Mini D-Sub 15 P), 1 Digital RGB (DVI-D 24 P, 8775 only), 1 Component Y, Cb/Pb, Cr/Pr (3 RCA), 2 Component (Mini D-Sub 15 P) shared with COMPUTER 1/2 input, 1 S-Video (Mini DIN 4P), 1 Video, 1 PC Card, 1 Stereo Mini Audio, 1 (L/R) RCA Audio, 1 PC Control (Mini D-Sub 9P)
Outputs	1 RGB (Mini D-Sub 15P), 1 Stereo Mini Audio
USB Port	1 A Type
LAN Port	RJ-45
Video Compatibility	NTSC, NTSC4.43, PAL, PAL-60, PAL-N, PAL-M, SECAM, HDTV: 1080i, 1080i/50Hz, 720p, 576p, 576i, 480p, 480i/60Hz
Scan Rate	Horizontal: 15 kHz to 100 kHz (RGB: 24 kHz or over) Vertical: 48 Hz to 120 Hz
Video Bandwidth	RGB: 100 MHz (-3dB)
Color Reproduction	16.7 million colors simultaneously, Full color
Horizontal Resolution	NTSC / NTSC4.43 / PAL / PAL-M / PAL-N / PAL60: 540 TV lines SECAM: 300 TV lines RGB: 1024 dots (H) × 768 dots (V)
External Control	RS232, IR, LAN, USB
Sync Compatibility	Separate Sync / Composite Sync / Sync on G
Built-in Speakers	1W × 1 (monaural)
Power Requirement	100 - 240V AC, 50/60Hz
Input Current	3.3 - 1.4A
Power Consumption	292W in Lamp Normal mode 230W in Lamp Eco mode 16W in Standby Normal mode, 10W in Standby Power-saving mode

* Effective pixels are more than 99.99%.

Mechanical

Installation	Orientation: Desktop/Front, Desktop/Rear, Ceiling/Front, Ceiling/Rear
Dimensions	11.6" (W) × 4.7" (H) × 11.3" (D) 294 mm (W) × 120 mm (H) × 288 mm (D) (not including protrusions)
Weight	7.7 lbs / 3.5 kg
Environmental Considerations	
Operational Temperatures :	41° to 104°F / 5° to 40°C, (Eco mode selected automatically at 95° to 104°F/35° to 40°C, operational temperatures during use of wireless LAN card: 41° to 95° F / 5° to 35°C), 20% to 80% humidity (non-condensing)
Storage Temperatures :	14° to 122°F (-10° to 50°C), 20% to 80% humidity (non-condensing)
Regulations	UL/C-UL Approved (UL 60950-1, CSA 60950-1) Meets DOC Canada Class B requirements Meets FCC Class B requirements Meets AS/NZS CISPR.22 Class B Meets EMC Directive (EN55022, EN55024, EN61000-3-2, EN61000-3-3) Meets Low Voltage Directive (EN60950-1, TÜV GS Approved)



For additional information visit:

US : www.dukcorp.com/a

The specifications are subject to change without notice.

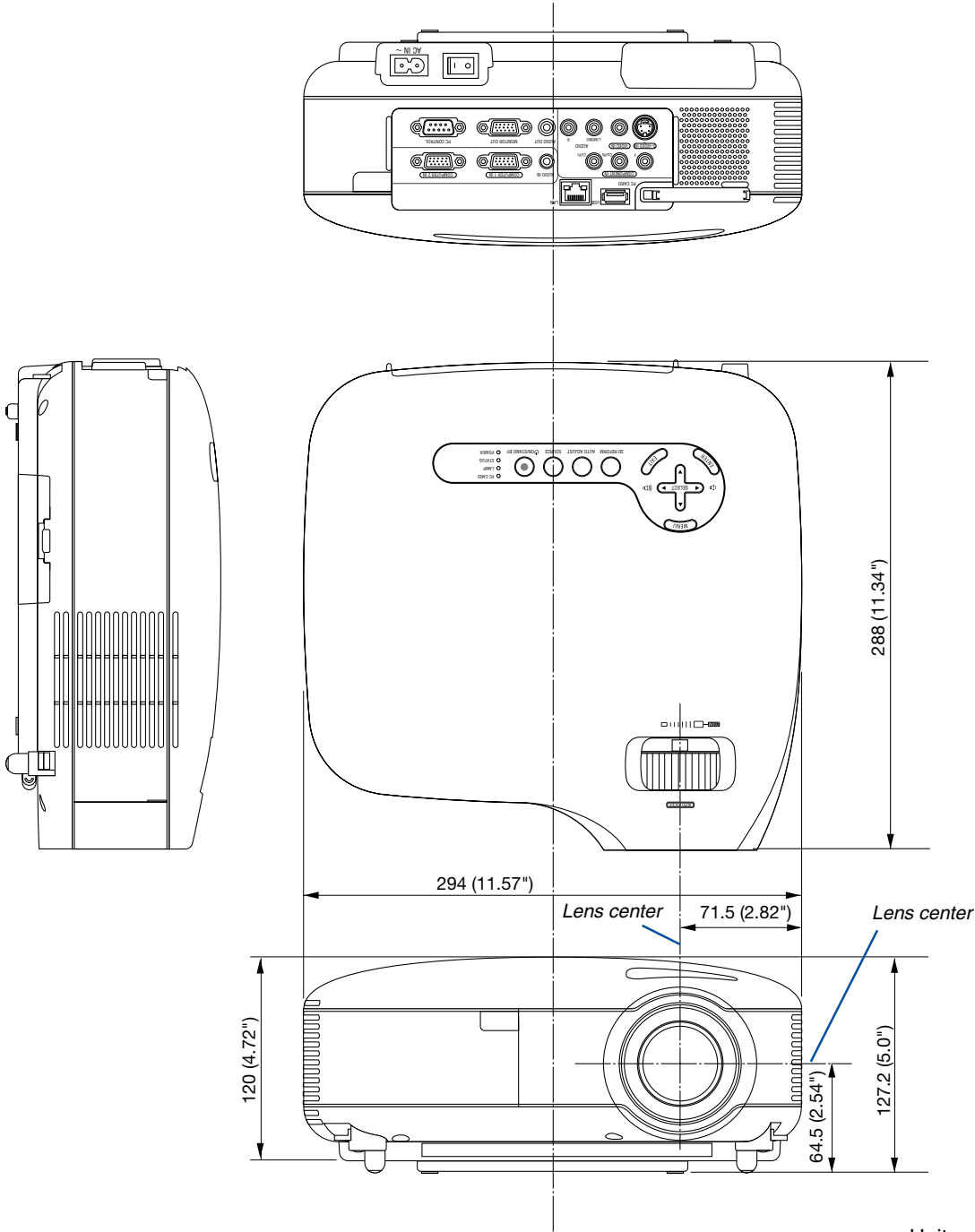

Unit: mm (inch)

④ Pin Assignments of D-Sub COMPUTER 1/2 Input Connector

Mini D-Sub 15 Pin Connector

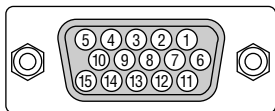

Signal Level

Video signal : 0.7Vp-p (Analog)

Sync signal : TTL level

* COMPUTER 1 IN connector only

Pin No.	RGB Signal (Analog)	YCbCr Signal
1	Red	Cr
2	Green or Sync on Green	Y
3	Blue	Cb
4	Ground	
5	Ground	
6	Red Ground	Cr Ground
7	Green Ground	Y Ground
8	Blue Ground	Cb Ground
9	No Connection	
10	Sync Signal Ground	
11	SCART Sync	
12	Bi-directional DATA (SDA)*	
13	Horizontal Sync or Composite Sync	
14	Vertical Sync	
15	Data Clock*	

5 Compatible Input Signal List

Signal	Resolution (Dots)	Frequency H. (kHz)	Refresh Rate (Hz)
NTSC	–	15.73	60.00
PAL	–	15.63	50.00
PAL60	–	15.73	60.00
SECAM	–	15.63	50.00
D VESA	640 × 480	31.47	59.94
D IBM	640 × 480	31.48	59.95
D MAC	640 × 480	35.00	66.67
D VESA	640 × 480	37.86	72.81
D VESA	640 × 480	37.50	75.00
D IBM	640 × 480	39.38	75.00
D VESA	640 × 480	43.27	85.01
D VESA	800 × 600	35.16	56.25
D VESA	800 × 600	37.88	60.32
D VESA	800 × 600	48.08	72.19
D VESA	800 × 600	46.88	75.00
D VESA	800 × 600	53.67	85.06
D MAC	832 × 624	49.72	74.55
D VESA	1024 × 768	48.36	60.00
D VESA	1024 × 768	56.48	70.07
D MAC	1024 × 768	60.24	74.93
D VESA	1024 × 768	60.02	75.03
D VESA	1024 × 768	68.68	85.00
# D VESA	1152 × 864	67.50	75.00
# D SUN	1152 × 900	61.80	65.95
# D VESA	1280 × 960	60.00	60.00
# D VESA	1280 × 1024	63.98	60.02
# MAC	1280 × 1024	69.87	65.18
# SXGA+	1400 × 1050	–	60.00
# VESA	1600 × 1200	75.00	60.00
# VESA	1600 × 1200	81.25	65.00
# VESA	1600 × 1200	87.50	70.00
# VESA	1600 × 1200	93.75	75.00
# D HDTV (1080i)(1125i)	1920 × 1080	33.75	60.00 Interlace
# D HDTV (1080i)(1125i)	1920 × 1080	28.13	50.00 Interlace
# D HDTV (720p)(750p)	1280 × 720	45.00	60.00 Progressive
# D HDTV (720p)	1280 × 720	37.50	50.00 Progressive
D SDTV(576p)(625p)	–	31.25	50.00 Progressive
D SDTV (480p)(525p)	–	31.47	59.94 Progressive
DVD YCbCr	–	15.73	59.94 Interlaced
DVD YCbCr	–	15.63	50.00 Interlaced

#: Signals in above flagged with # are compressed with Advanced AccuBlend.

D: Images above flagged with "D" are supported by digital signal.

NOTE: Some composite sync signals may not be displayed correctly.

Signals other than those specified in the table above may not be displayed correctly. If this should happen, change the refresh rate or resolution on your PC. Refer to Display Properties help section of your PC for procedures.

UXGA (1600 × 1200) is supported for separate sync signal only.

6 PC Control Codes and Cable Connection

PC Control Codes

Function	Code Data											
POWER ON	02H	00H	00H	00H	00H	02H						
POWER OFF	02H	01H	00H	00H	00H	03H						
INPUT SELECT COMPUTER 1	02H	03H	00H	00H	02H	01H	01H	09H				
INPUT SELECT COMPUTER 2	02H	03H	00H	00H	02H	01H	02H	0AH				
INPUT SELECT COMPUTER 3	02H	03H	00H	00H	02H	01H	1AH	22H				
INPUT SELECT COMPONENT	02H	03H	00H	00H	02H	01H	10H	18H				
INPUT SELECT VIDEO	02H	03H	00H	00H	02H	01H	06H	0EH				
INPUT SELECT S-VIDEO	02H	03H	00H	00H	02H	01H	0BH	13H				
INPUT SELECT VIEWER	02H	03H	00H	00H	02H	01H	1FH	27H				
PICTURE MUTE ON	02H	10H	00H	00H	00H	12H						
PICTURE MUTE OFF	02H	11H	00H	00H	00H	13H						
SOUND MUTE ON	02H	12H	00H	00H	00H	14H						
SOUND MUTE OFF	02H	13H	00H	00H	00H	15H						
ON SCREEN MUTE ON	02H	14H	00H	00H	00H	16H						
ON SCREEN MUTE OFF	02H	15H	00H	00H	00H	17H						
ASPECT RATIO (4:3 Screen)												
4:3	03H	10H	00H	00H	05H	18H	00H	00H	00H	00H	00H	30H
Letterbox	03H	10H	00H	00H	05H	18H	00H	00H	01H	00H	00H	31H
Widescreen	03H	10H	00H	00H	05H	18H	00H	00H	02H	00H	00H	32H
Crop	03H	10H	00H	00H	05H	18H	00H	00H	03H	00H	00H	33H
ASPECT RATIO (16:9 Screen)												
4:3 Window	03H	10H	00H	00H	05H	18H	00H	00H	00H	00H	00H	30H
Letterbox	03H	10H	00H	00H	05H	18H	00H	00H	01H	00H	00H	31H
Widescreen	03H	10H	00H	00H	05H	18H	00H	00H	02H	00H	00H	32H
4:3 Fill	03H	10H	00H	00H	05H	18H	00H	00H	04H	00H	00H	34H
AUTO ADJUST	02H	0FH	00H	00H	02H	05H	00H	18H				

NOTE: Contact your local dealer for a full list of PC Control Codes if needed.

Cable Connection

Communication Protocol

Baud rate 38400 bps
 Data length 8 bits
 Parity No parity
 Stop bit One bit
 X on/off None
 Communications procedure Full duplex

NOTE: Depending on the equipment, a lower baud rate may be recommended for long cable runs.

PC Control Connector (D-SUB 9P)

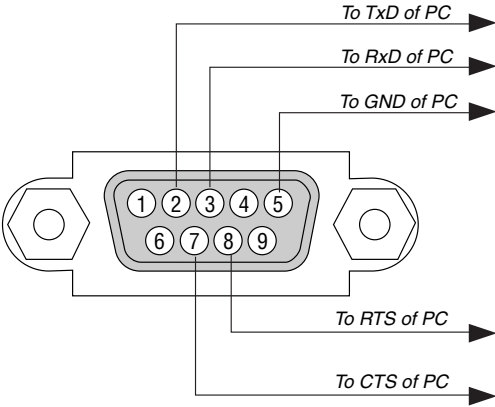

NOTE 1: Pins 1, 4, 6 and 9 are no used.

NOTE 2: Jumper "Request to Send" and "Clear to Send" together on both ends of the cable to simplify cable connection.

NOTE 3: For long cable runs it is recommended to set communication speed within projector menus to 9600 bps.

7 Using Software Keyboard

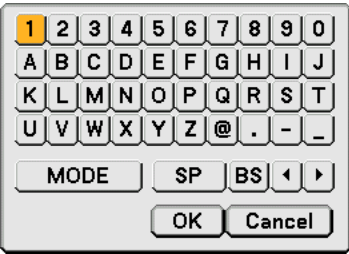

- 1 to 0 and Characters Use to type in password or keyword.
- MODE Selects one of three modes for alphabet and special characters.
- SP Inserts a space
- BS Deletes one character backward
- ◀ Returns to the previous
- ▶ Advances to the next
- OK Executes the selection
- Cancel Cancels the selection

NOTE: You can drag the Software keyboard on the screen by clicking and holding any part on the keyboard except buttons.

8 Troubleshooting Check List

Before contacting your dealer or service personnel, check the following list to be sure repairs are needed also by referring to the "Troubleshooting" section in your user's manual. This checklist below will help us solve your problem more efficiently.

* Print the following pages.

Frequency of occurrence always sometimes (How often? _____) other (_____)

Power

- | | |
|--|--|
| <ul style="list-style-type: none"> <input type="checkbox"/> No power (POWER indicator does not light green) See also "Status Indicator (STATUS)". <ul style="list-style-type: none"> <input type="checkbox"/> Power cable's plug is fully inserted into the wall outlet. <input type="checkbox"/> Main power switch is pressed to the ON position. <input type="checkbox"/> Lamp cover is installed correctly . <input type="checkbox"/> Lamp Hours Used (lamp operation hours) was cleared after lamp replacement. <input type="checkbox"/> No power even though you press and hold the POWER button for a minimum of 2 seconds. | <ul style="list-style-type: none"> <input type="checkbox"/> Shut down during operation. <ul style="list-style-type: none"> <input type="checkbox"/> Power cable's plug is fully inserted into the wall outlet. <input type="checkbox"/> Lamp cover is installed correctly . <input type="checkbox"/> Power Management is turned off (only models with the Power Management function). <input type="checkbox"/> Off Timer is turned off (only models with the Off Timer function). |
|--|--|

Video and Audio

- | | |
|--|--|
| <ul style="list-style-type: none"> <input type="checkbox"/> No image is displayed from your PC or video equipment to the projector. <ul style="list-style-type: none"> <input type="checkbox"/> Still no image even though you connect the projector to the PC first, then start the PC. <input type="checkbox"/> Enabling your notebook PC's signal output to the projector. <ul style="list-style-type: none"> • <i>A combination of function keys will enable/disable the external display. Usually, the combination of the "Fn" key along with one of the 12 function keys turns the external display on or off.</i> <input type="checkbox"/> No image (blue background, logo, no display). <input type="checkbox"/> Still no image even though you press the AUTO ADJUST button. <input type="checkbox"/> Still no image even though you carry out [Reset] in the projector's menu. <input type="checkbox"/> Signal cable's plug is fully inserted into the input connector <input type="checkbox"/> A message appears on the screen.
(_____) <input type="checkbox"/> The source connected to the projector is active and available. <input type="checkbox"/> Still no image even though you adjust the brightness and/or the contrast. <input type="checkbox"/> Input source's resolution and frequency are supported by the projector. <input type="checkbox"/> Image is too dark. <ul style="list-style-type: none"> <input type="checkbox"/> Remains unchanged even though you adjust the brightness and/or the contrast. <input type="checkbox"/> Image is distorted. <ul style="list-style-type: none"> <input type="checkbox"/> Image appears to be trapezoidal (unchanged even though you carry out the [Keystone] or [3D Reform] adjustment). | <ul style="list-style-type: none"> <input type="checkbox"/> Parts of the image are lost. <ul style="list-style-type: none"> <input type="checkbox"/> Still unchanged even though you press the AUTO ADJUST button. <input type="checkbox"/> Still unchanged even though you carry out [Reset] in the projector's menu. <input type="checkbox"/> Image is shifted in the vertical or horizontal direction. <ul style="list-style-type: none"> <input type="checkbox"/> Horizontal and vertical positions are correctly adjusted on a computer signal. <input type="checkbox"/> Input source's resolution and frequency are supported by the projector. <input type="checkbox"/> Some pixels are lost. <input type="checkbox"/> Image is flickering. <ul style="list-style-type: none"> <input type="checkbox"/> Still unchanged even though you press the AUTO ADJUST button. <input type="checkbox"/> Still unchanged even though you carry out [Reset] in the projector's menu. <input type="checkbox"/> Image shows flickering or color drift on a computer signal. <input type="checkbox"/> Image appears blurry or out of focus. <ul style="list-style-type: none"> <input type="checkbox"/> Still unchanged even though you checked the signal's resolution on PC and changed it to projector's native resolution. <input type="checkbox"/> Still unchanged even though you adjusted the focus. <input type="checkbox"/> No sound. <ul style="list-style-type: none"> <input type="checkbox"/> Audio cable is correctly connected to the audio input of the projector. <input type="checkbox"/> Still unchanged even though you adjusted the volume level. <input type="checkbox"/> AUDIO OUT is connected to your audio equipment (only models with the AUDIO OUT connector). |
|--|--|

Other

- | | |
|--|--|
| <ul style="list-style-type: none"> <input type="checkbox"/> Remote control does not work. <ul style="list-style-type: none"> <input type="checkbox"/> No obstacles between the sensor of the projector and the remote control. <input type="checkbox"/> Projector is placed near a fluorescent light that can disturb the infrared remote controls. <input type="checkbox"/> Batteries are new and are not reversed in installation. <input type="checkbox"/> If present on the remote control, projector selector switch is not used. | <ul style="list-style-type: none"> <input type="checkbox"/> Buttons on the projector cabinet do not work (only models with the Control Panel Lock function). <ul style="list-style-type: none"> <input type="checkbox"/> Control Panel Lock is not turned on or is disabled in the menu. <input type="checkbox"/> Still unchanged even though you press and hold the EXIT button for a minimum of 10 seconds. |
|--|--|

In the space below please describe your problem in detail.

Information on application and environment where your projector is used

Projector

Model number:

Serial No.:

Date of purchase:

Lamp operating time (hours):

Lamp Mode: Normal Eco

Information on input signal:

Horizontal synch frequency [] kHz

Vertical synch frequency [] Hz

Synch polarity H (+) (-)

V (+) (-)

Synch type Separate Composite

Sync on Green

STATUS Indicator:

Steady light Orange Green

Flashing light [] cycles

Remote control model number:

Installation environment

Screen size: inch

Screen type: White matte Beads Polarization

Wide angle High contrast

Throw distance: feet/inch/m

Orientation: Ceiling mount Desktop

Power outlet connection:

Connected directly to wall outlet

Connected to power cord extender or other (the number of connected equipment _____)

Connected to a power cord reel or other (the number of connected equipment _____)

Computer

Manufacturer:

Model number:

Notebook PC / Desktop

Native resolution:

Refresh rate:

Video adapter:

Other:

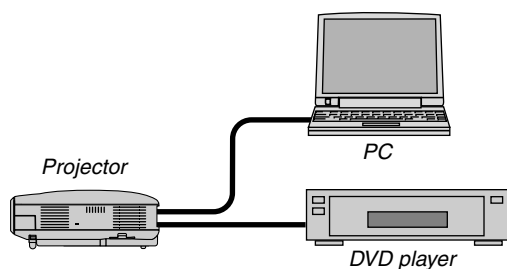

Signal cable

Dukane standard or other manufacturer's cable?

Model number: Length: inch/m

Distribution amplifier

Model number:

Switcher

Model number:

Adapter

Model number:

Video equipment

VCR, DVD player, Video camera, Video game or other

Manufacturer:

Model number:

2900 Dukane Drive
St. Charles, Illinois 60174
www.dukcorp.com/av

Toll-free: 800-676-2487
Fax: 630-584-5156
e-mail: avsales@dukcorp.com

Audio Visual Products

DUKANE